

Input Voltage	Output voltage	Output current	Output Power	Efficiency	Dimension
10-20V	48V	4A	192W	95.2%	74*74*32mm

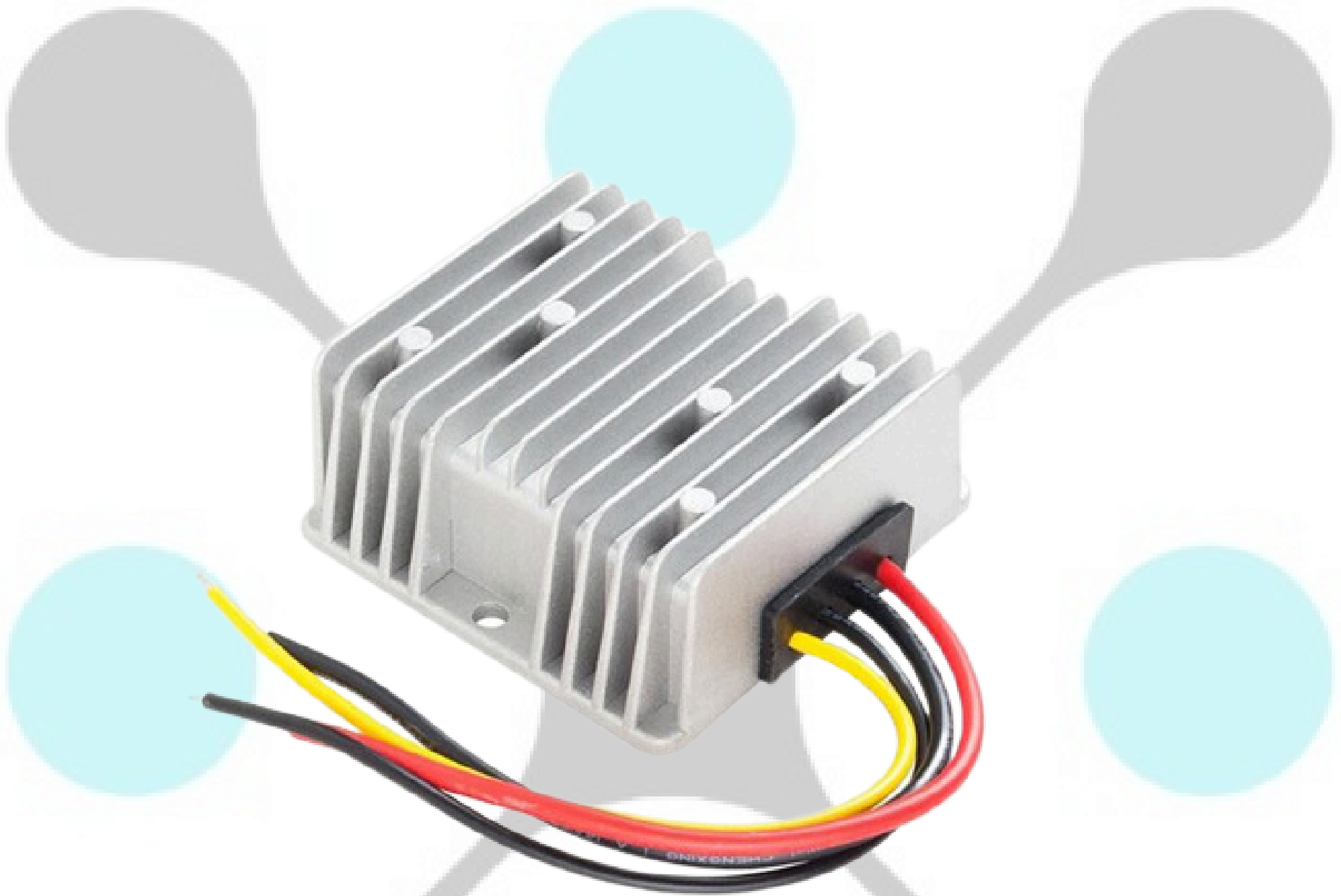

The RW-942-12-48V-192W is a Non-isolated DC-DC converter that uses a synchronous rectification technology, and features high efficiency and power density. It has the dimensions of 74mm x 74mm x 32mm (2.91 in. x 2.91 in. x 1.26 in) and provides the rated output voltage of 48V and the maximum output current of 4A.

## Features

- Design meeting RoHS / CE
- High efficiency: 95.2%(@ 12Vin, 25°C)
- Non-isolated between input and output
- Import capacitors, high reliability
- Support -40 °C environment
- 100% full load burn-in test
- 3 month warranty
- Over load, Low voltage protections
- Waterproof level IP68
- Die-cast aluminum shell, epoxy potting

## Applications

- Industrial
- Alternative Energy
- Golf Cart
- Forklift
- Electromotor
- Telecommunications
- Boat & Yacht
- RVs/EV
- LED Marketplaces and so on

## Model naming method

**RW-942-12-48V-192W**

**RW-942 : SKU NAME**  
**12: Input voltage range**  
**48V: Output voltage**  
**192W: POWER**

### Datasheet

Parameter	Min	Typ	Max	Units	Remakrs
<b>Absolute maximum ratings</b>					
Operating ambient temperature	-40	-	+55	°C	
Shell ambient temperature	-40	-	80	°C	
Storage temperature	-55	-	100	°C	
Operating humidity	5	-	95	%	Non-condensing
Atmospheric pressure	62	-	106	kpa	
Altitude	-	-	4000	m	
Cooling way	-	-	-		Natural cooling
<b>Input characteristics</b>					
Input voltage	10	12	20	V	
Max. input voltage	-	-	20	V	Continuous
Undervoltage shutdown	9.7	9.9	10.1	V	Automatic recovery
Undervoltage recovery	10.0	10.5	11.0	V	Automatic recovery
Max. input current	-	-	19.7	A	Vin =10.2V; Iout =4A
No load current	-	114	100	mA	Vin =12V
Positive electrode cable	14	-	-	AWG	If the wire length is greater than 50cm, it is recommended to use a thicker wire diameter.
Negative electrode cable	14	-	-	AWG	

Enable PIN cable	-	NA	-	AWG	If the unit with this function
Fuse	-	30	-	A	Input positive has built-in fuse
<b>Output characteristics</b>					
Efficiency	-	95.2	-	%	Vin =12V; Iout =4A
Output voltage	47.8	48.0	48.4	V	Vin =12V; Iout =4A
Regulator accuracy	-	±3	-	%	
Voltage regulation	-	±1	-	%	
Load Regulation	-	±1	-	%	
Overvoltage protection	-	NA	-	V	
Output current	0	-	4	A	
Overcurrent protection	6	7	8	A	Vin=12V
External capacitance	-	NA	-	µF	Don't need
Output ripple and noise	-	644	700	mVp-p	Vin =10-20V; Iout=4A, Oscilloscope bandwidth: 20 MHz
Output voltage risetime	-	15	20	mS	
Boot delay time	-	5	20	mS	
Out voltage overshoot	-	-	3	%	Vin =12V, 50%-75% Load step
Over temperatur protection	-	NA	-	°C	Shell test

Short circuit protection	-	NA	-		<b>Output can't shorted for boost converters</b>
Positive electrode cable	16	-	-	AWG	If the wire length is greater than 50cm, it is recommended to use a thicker wire diameter
Negative electrode cable	16	-	-	AWG	
<b>Safety and EMC features</b>					
Anti-electric Strength	Input to Output	-	V	Leakage current $\leq$ 3.5mA, 1min, no breakdown, no arcing	
	Input to Shell	$\geq 500$	V		
	Output to Shell	$\geq 500$	V		
Insulation resistance	Input to Output	$\geq 10$	M $\Omega$	Test voltage = 500V	
	Input to Shell				
	Output to Shell				
<b>Other characteristics</b>					
Weight	$\leq 300$	g			
Package	white box				
MTBF	$\geq 200,000$	H	Vin= 12V; Iout= 4A		
Switching frequency	100 $\pm$ 10	KHz			



### Characteristic Curves

Conditions:  $T_A = 25^\circ\text{C}$  (77°F),  $V_{in} = 12\text{V}$ ,  $V_{out} = 48\text{V}$ , unless otherwise specified.

**Figure 1, Efficiency**

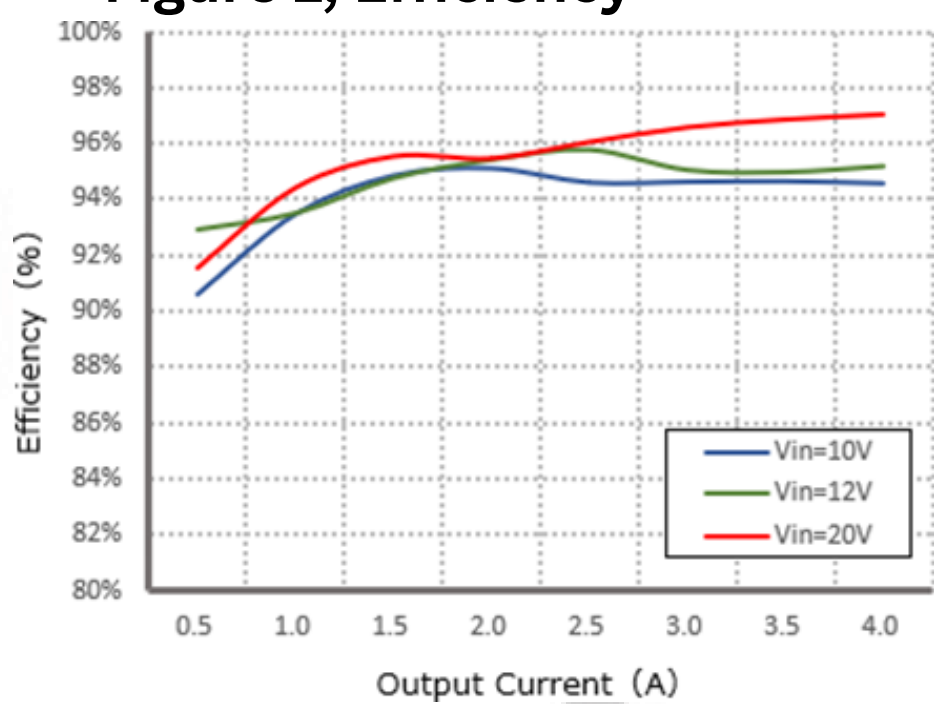

**Figure 2, Power dissipation**

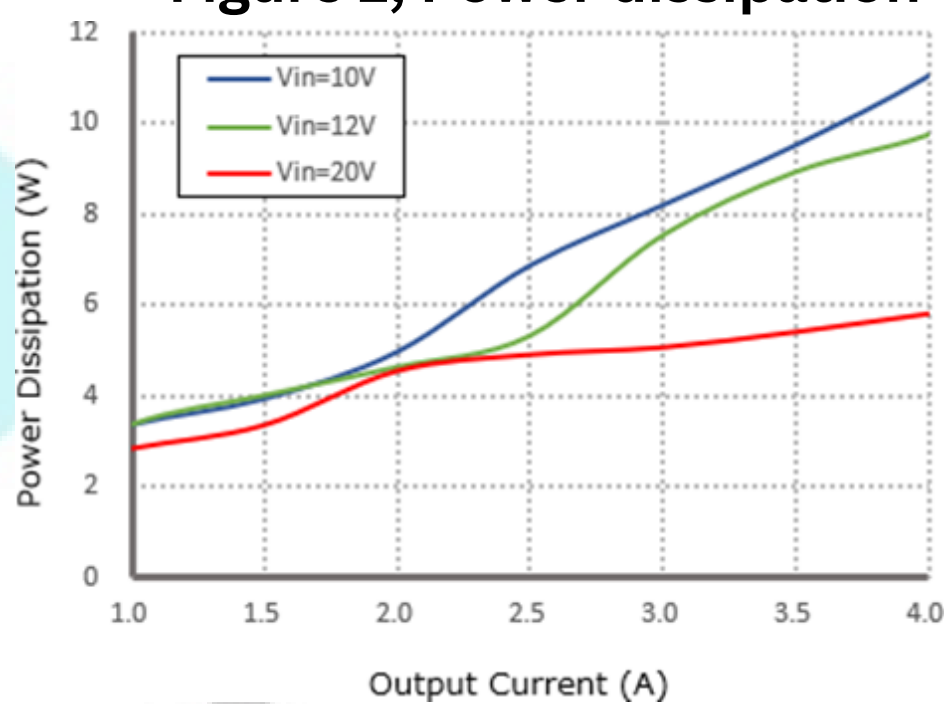

**Figure 3, Input V-I, Iout=20A**

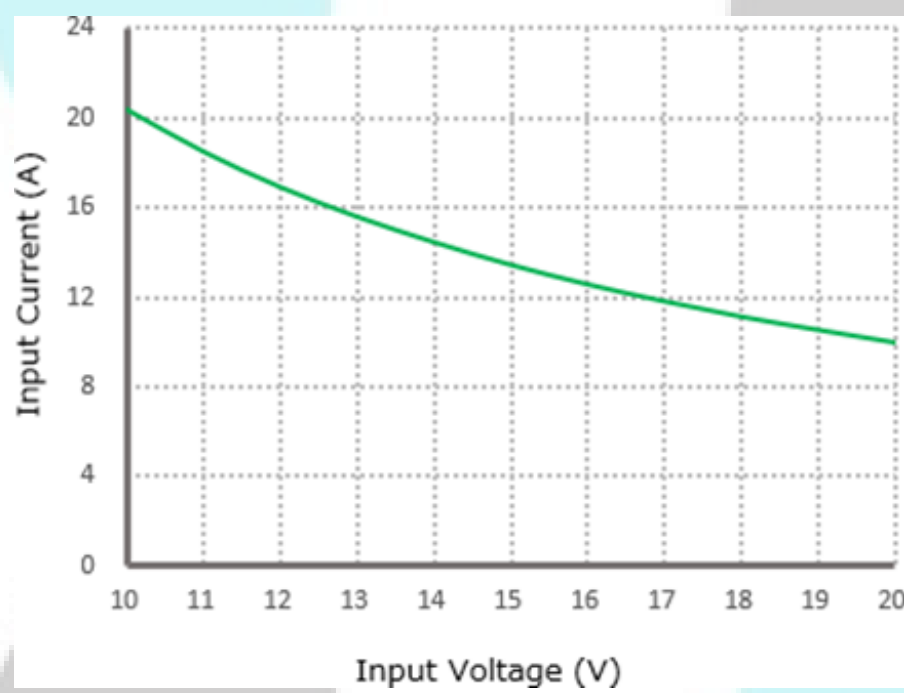

### Typical Waveforms

Conditions: TA = 25°C (77°F), Vin = 12V, unless otherwise specified.

Figure 4, 25% - 50% load dynamic

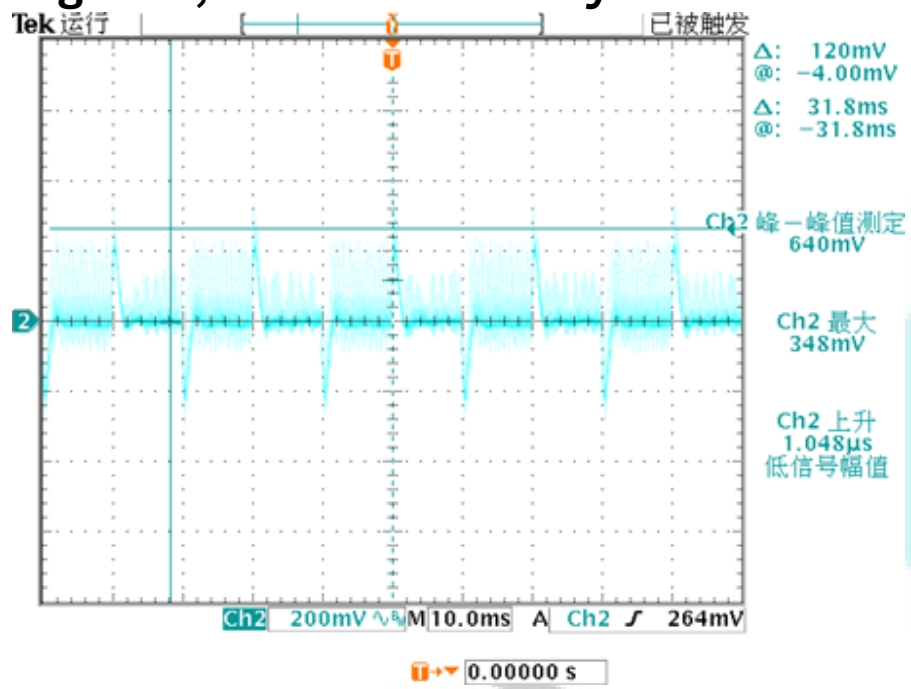

Figure 5, 50% - 75% load dynamic

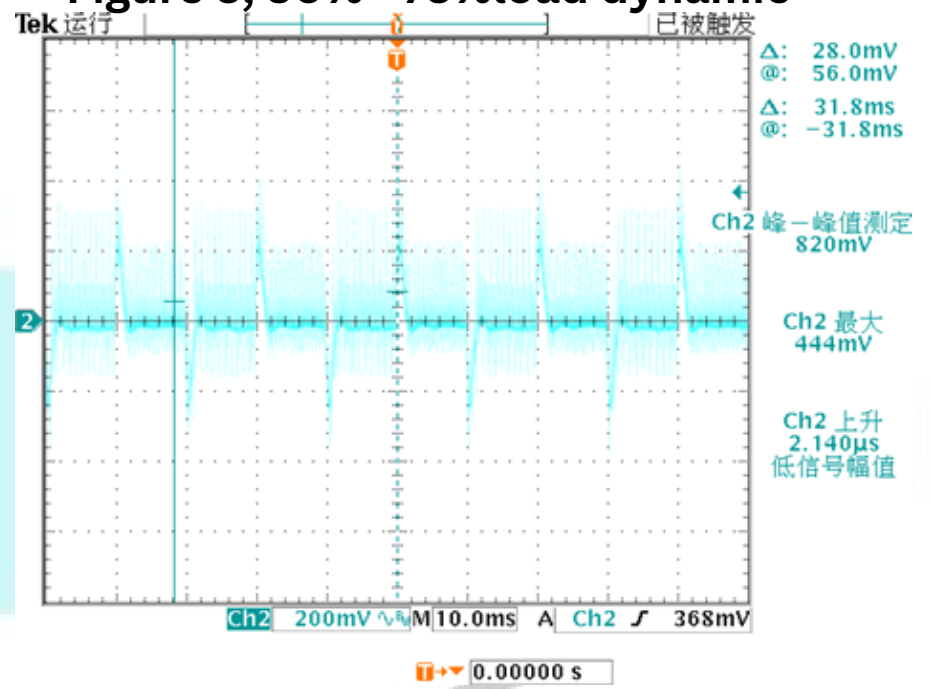

Figure 6, Output voltage established (Iout = 20A)

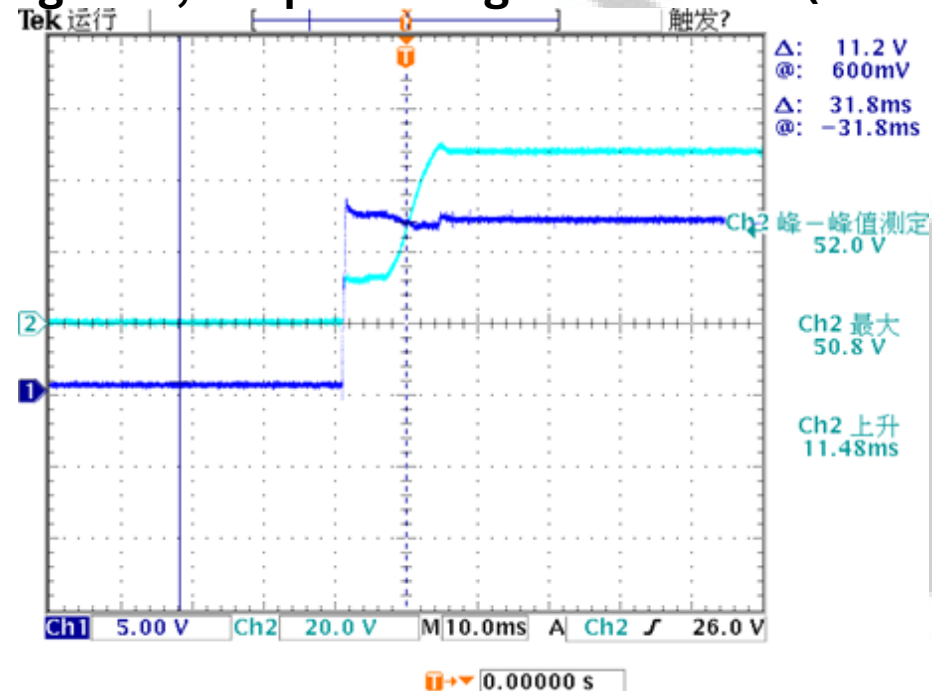
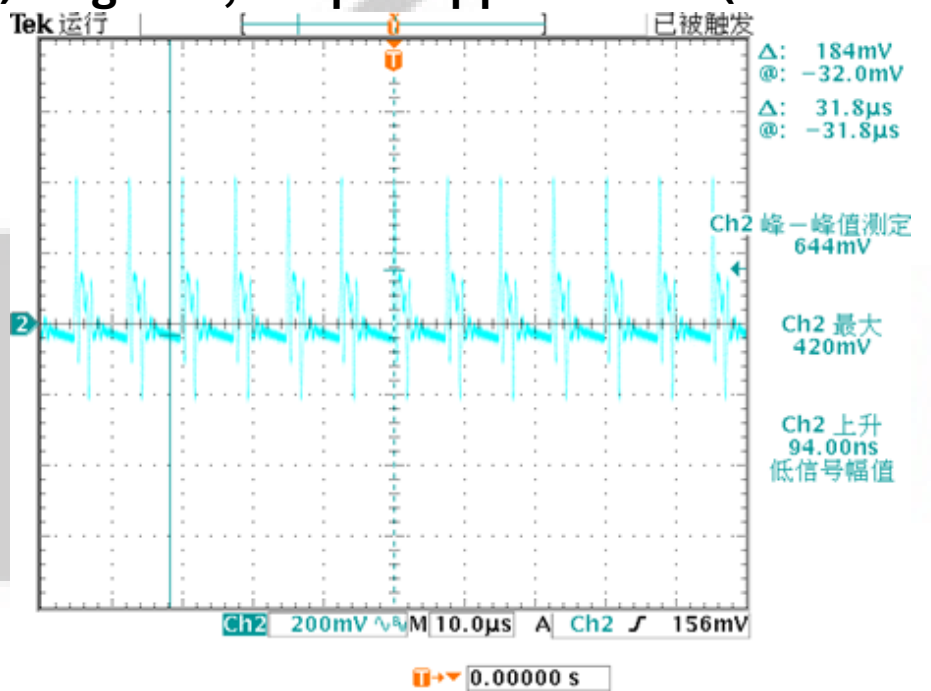

Figure 7, Output ripple & noise (Iout = 20A)



### Feature Description

#### Remote On/Off (EN) (Optional)

Logic Enable	Low level (0-10Vdc)	High level (10-20Vdc)	Left open
positive logic	Off	On	Off

#### Input Undervoltage Protection

The converter will shut down after the input voltage drops below the under-voltage protection threshold for shutdown. The converter will start to work again after the input voltage reaches the input under voltage protection threshold for startup. For the Hysteresis, see the Protection characteristics.

#### Various circuits for driving the EN

#### Output Overcurrent Protection

The converter equipped with current limiting circuitry can provide protection from an output overload or short circuit condition. If the output current exceeds the output overcurrent protection set point, the converter enters hiccup mode. When the fault condition is removed, the converter will automatically restart

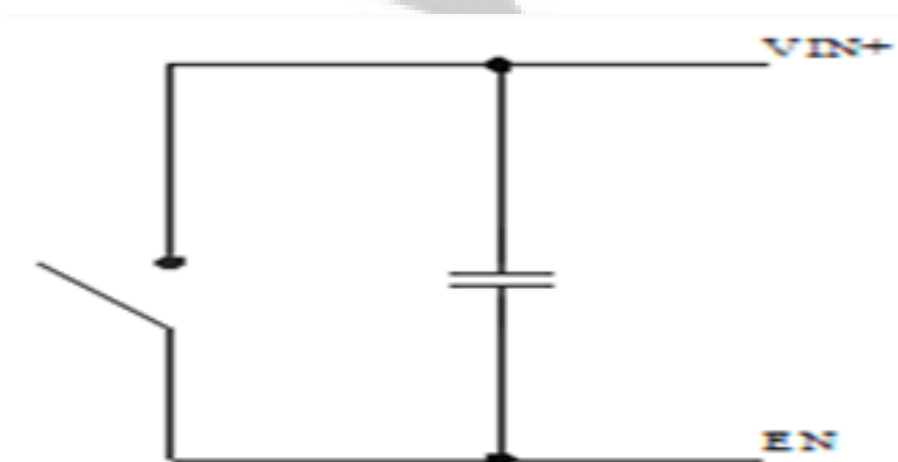

Simple control

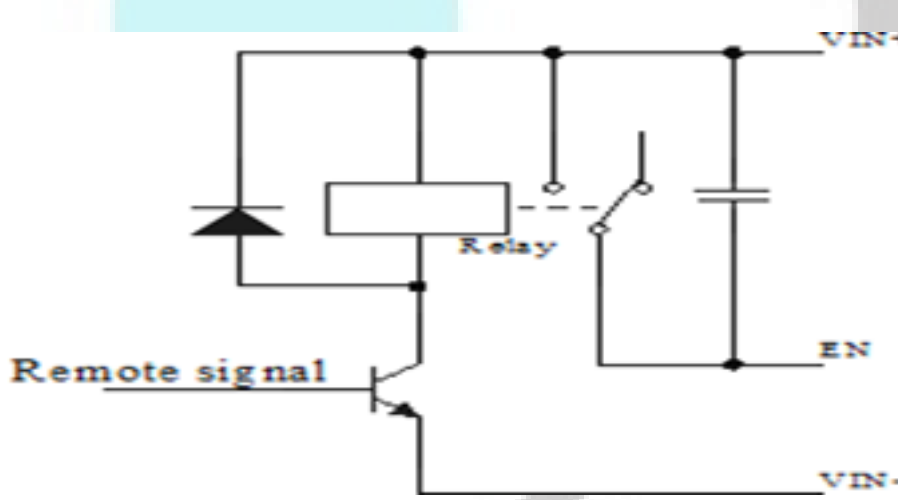

Transistor control

#### Wiring Instructions

The input and output of this product is terminals. The user should ensure that the input and output wires and terminals are connected reliably, and pay attention to the wire diameter to meet the requirements of the power supply current. If the cable to be used is long, it needs Considering the voltage drop of the wire, if the voltage drop is too large, the voltage output at the load end may not meet the load demand. In this case, consider using a thicker wire diameter or reducing the length of the wire. Generally, if long wiring is required. Long line should be used on the side where the current is relatively small. For example, this product is a step-down product, so long lines should be used on the input side



### Thermal Consideration

Sufficient airflow should be provided to help ensure reliable operating of the RW-936-9-40-24V-144W. Therefore, thermal components are mounted on the top surface of the RW-936-9-40-24V-144W to dissipate heat to the surrounding environment by conduction, convection, and radiation. Proper airflow can be verified by measuring the temperature at the middle of the base plate.

