

Input Voltage	Output voltage	Output current	Output Power	Efficiency	Dimension
18-36V	12V	15A	180W	96.5%	74*74*32mm

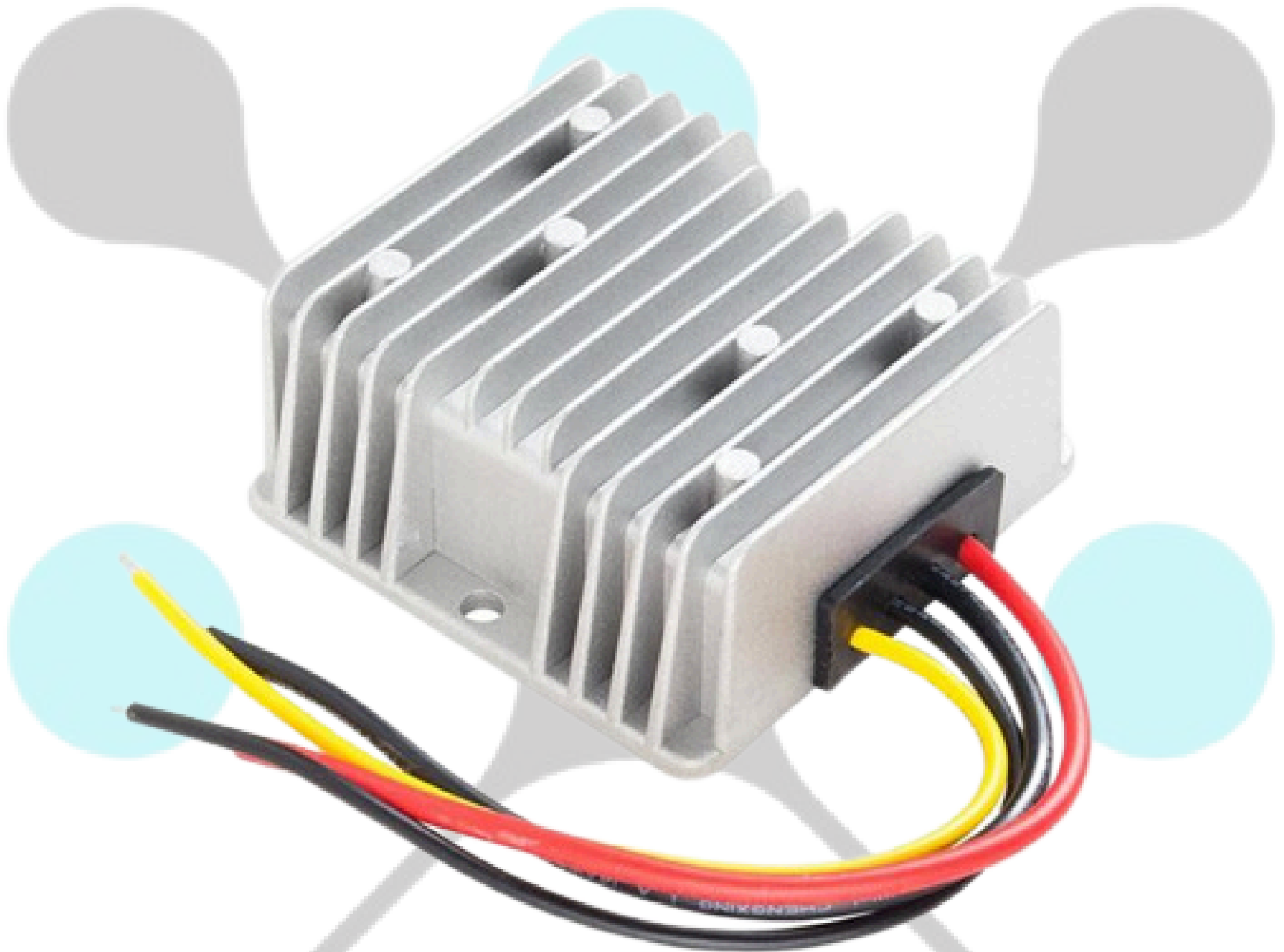

The RW-982-24-12V-180W is a Non-isolated DC-DC converter that uses a synchronous rectification technology, and features high efficiency and power density. It has the dimensions of 74mm x 74mm x 32mm (2.91 in. x 2.91 in. x 1.26 in) and provides the rated output voltage of 12V and the maximum output current of 15A

Features

- Design meeting RoHS / CE
- High efficiency: 96.5%(@ 12Vin, 25°C)
- Import capacitors, high reliability
- Output transient absorption protection
- Support -40 °C environment
- 100% full load burn-in test
- 3 month warranty
- Remote ON/OFF control(optional)
- Waterproof level IP68
- Short circuit, Over load, Over temperature protections

Applications

- Industrial
- Alternative Energy
- Golf Cart
- Forklift
- Electromotor
- Telecommunications
- Boat & Yacht
- Medical
- LED Marketplaces and so on

Model naming method

RW-982-24-12V-180W

RW-982: SKU NAME
24: Input voltage range
12V: Output voltage
180W: POWER

Datasheet

Parameter	Min	Typ	Max	Units	Remakrs
Absolute maximum ratings					
Operating ambient temperature	-40	-	+55	°C	
Shell ambient temperature	-40	-	80	°C	
Storage temperature	-55	-	100	°C	
Operating humidity	5	-	95	%	Non-condensing
Atmospheric pressure	62	-	106	kpa	
Altitude	-	-	4000	m	
Cooling way	-	-	-		Natural cooling
Input characteristics					
Input voltage	18	24	36	V	
Max. input voltage	-	-	36	V	Continuous
Undervoltage shutdown	15.9	16.1	16.3	V	Automatic recovery
Undervoltage recovery	16.5	16.6	16.7	V	Automatic recovery
Max. input current	-	-	12	A	Vin =18V; Iout =15A
No load current	-	34	38	mA	Vin =24V
Positive electrode cable	16	-	-	AWG	If the wire length is greater than 50cm, it is recommended to use a thicker wire diameter.
Negative electrode cable	16	-	-	AWG	

Enable PIN cable	/	-	-	AWG	If the unit with this function
Fuse	-	20	-	A	Input positive has built-in fuse
Output characteristics					
Efficiency	-	96.5	-	%	Vin =24V; Iout =15A
Output voltage	11.9	12.0	12.3	V	Vin =24V; Iout =15A
Regulator accuracy	-	±1	-	%	
Voltage regulation	-	±2	-	%	
Load Regulation	-	±2	-	%	
Overvoltage protection	-	14.5	16.0	V	TVS clamp protection
Output current	0	-	15	A	
Overcurrent protection	15	25	28	A	Vin=24V
External capacitance	-	NA	-	μF	Don't need
Output ripple and noise	-	40	50	mVp-p	Vin =18-36V; Iout=15A, Oscilloscope bandwidth: 20 MHz
Output voltage risetime	-	75	75	mS	
Boot delay time	-	96	100	mS	
Out voltage overshoot	-	1	2	%	Vin =24V, 50%-75%Load step
Over temperatur protection	-	-	100	°C	Shell temperature, @ 100°C Restoreworking

Short circuit protection	-	YES	-		Long-term (4 hours) short circuit is not damaged, Hiccup mode
Positive electrode cable	14	-	-	AWG	If the wire length is greater than 50cm, it is recommended to use a thicker wire diameter
Negative electrode cable	14	-	-	AWG	
Safety and EMC features					
Anti-electric Strength	Input to Output	-	V	Leakage current \leq 3.5mA, 1min, no breakdown, no arcing	
	Input to Shell	≥ 500	V		
	Output to Shell	≥ 500	V		
Insulation resistance	Input to Output	≥ 10	M Ω	Test voltage = 500V	
	Input to Shell				
	Output to Shell				
Other characteristics					
Weight	≤ 290	g			
Package	white box				
MTBF	$\geq 200,000$	H	Vin= 24V; Iout= 15A		
Switching frequency	100 \pm 10	KHz			

Characteristic Curves

Conditions: $T_A = 25^\circ\text{C}$ (77°F), $V_{in} = 24\text{ V}$, $V_{out} = 12\text{ V}$, unless otherwise specified.

Figure 1, Efficiency

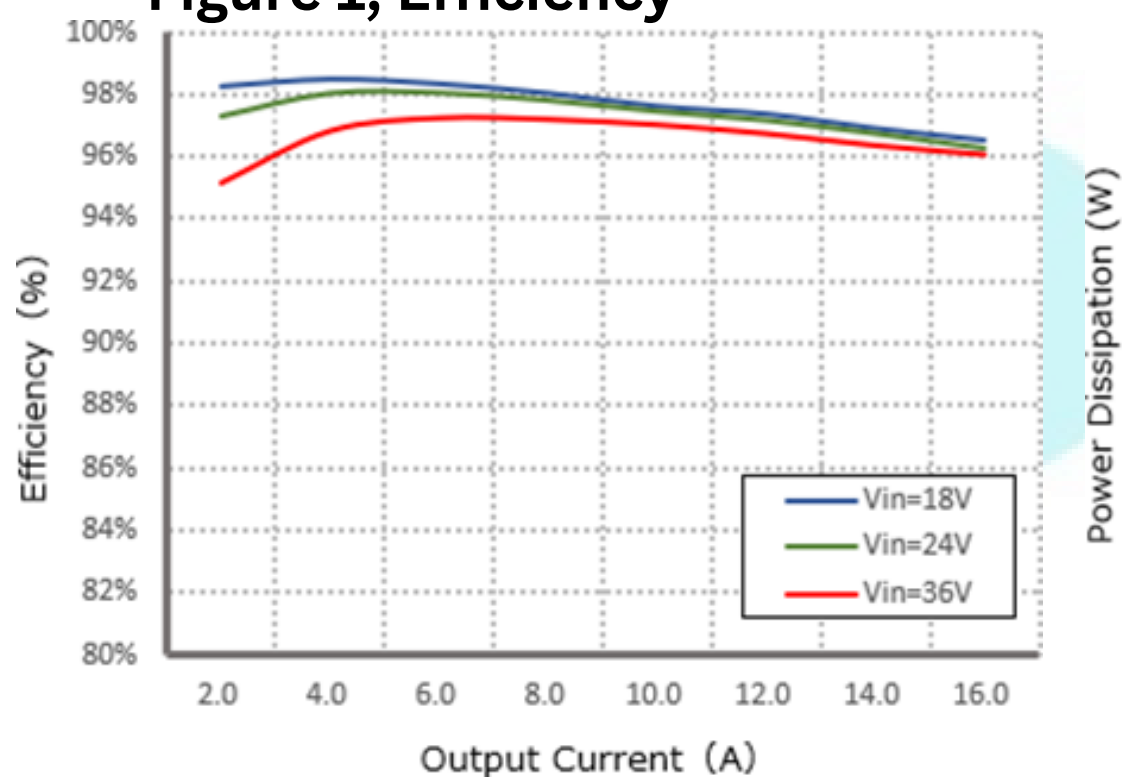

Figure 2, Power dissipation

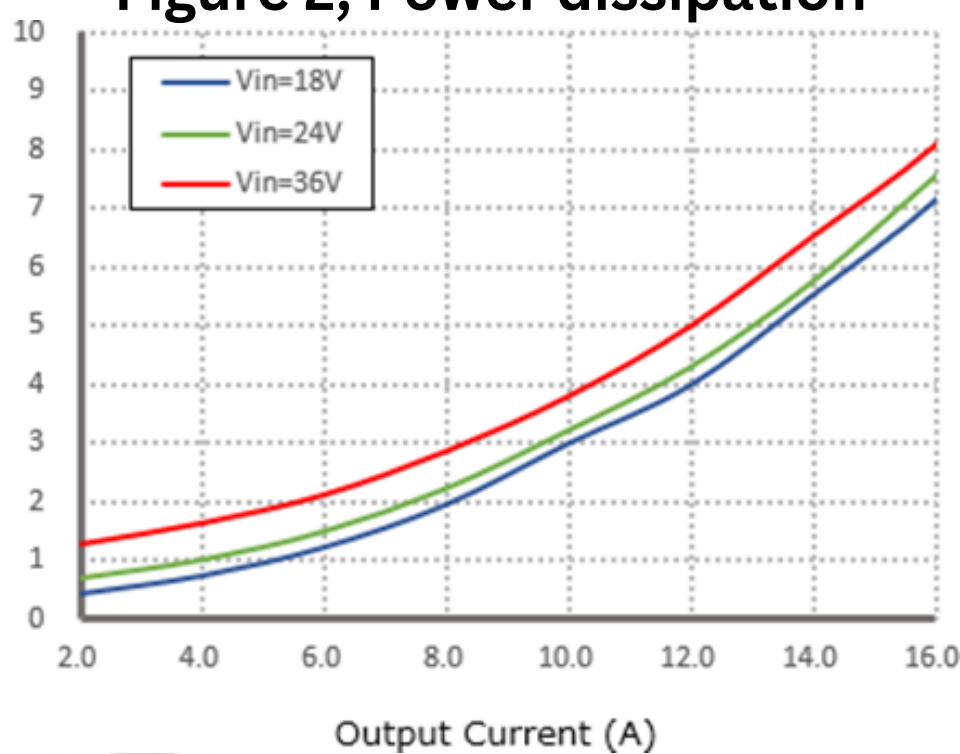
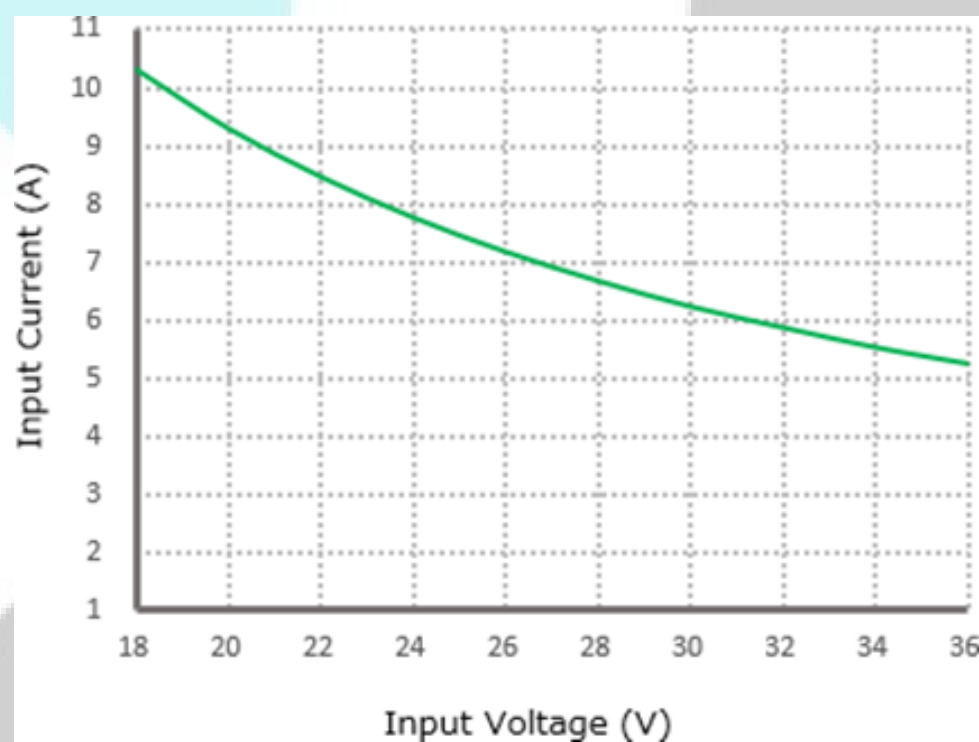

Figure 3, Input V-I, Iout=15A



Typical Waveforms

Conditions: TA = 25°C (77°F), Vin = 24V, unless otherwise specified.

Figure 4, 25% - 50% load dynamic

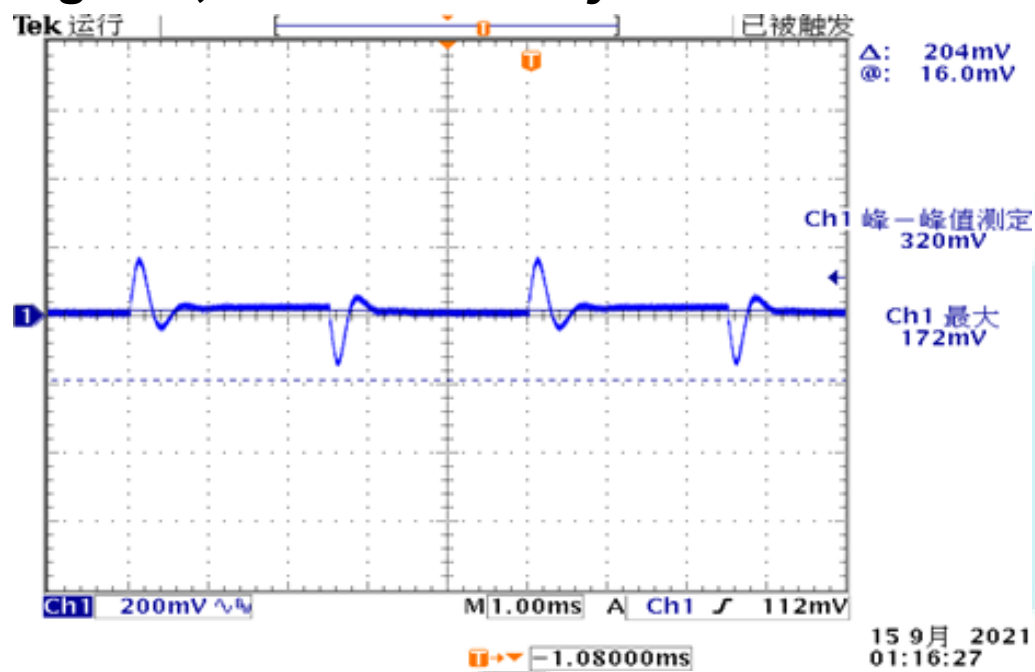

Figure 5, 50% - 75% load dynamic

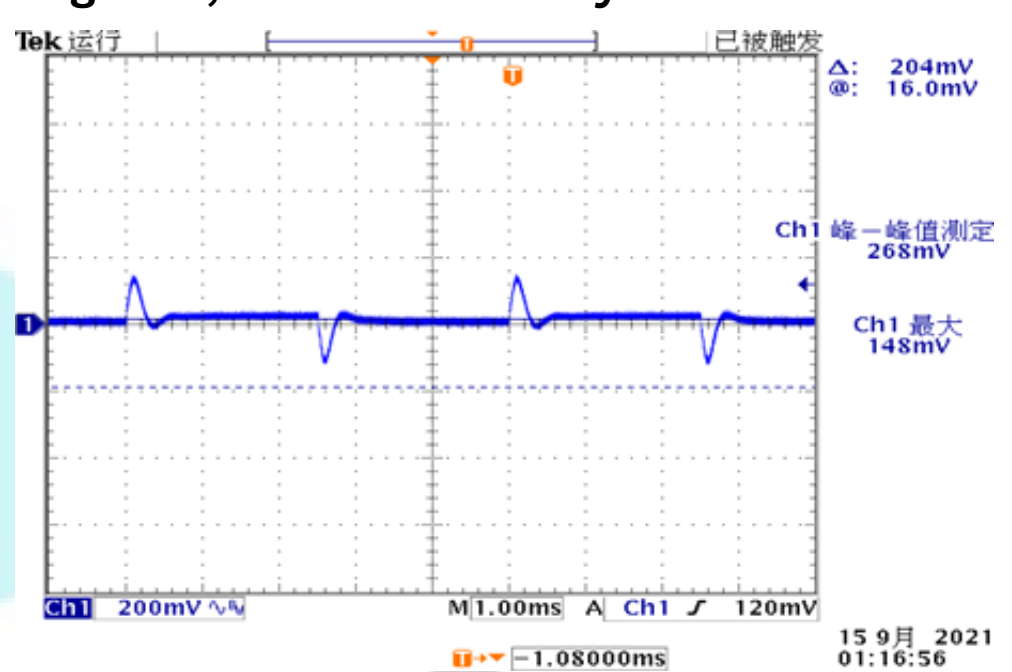

Figure 6, Output voltage established (Iout = 15A)

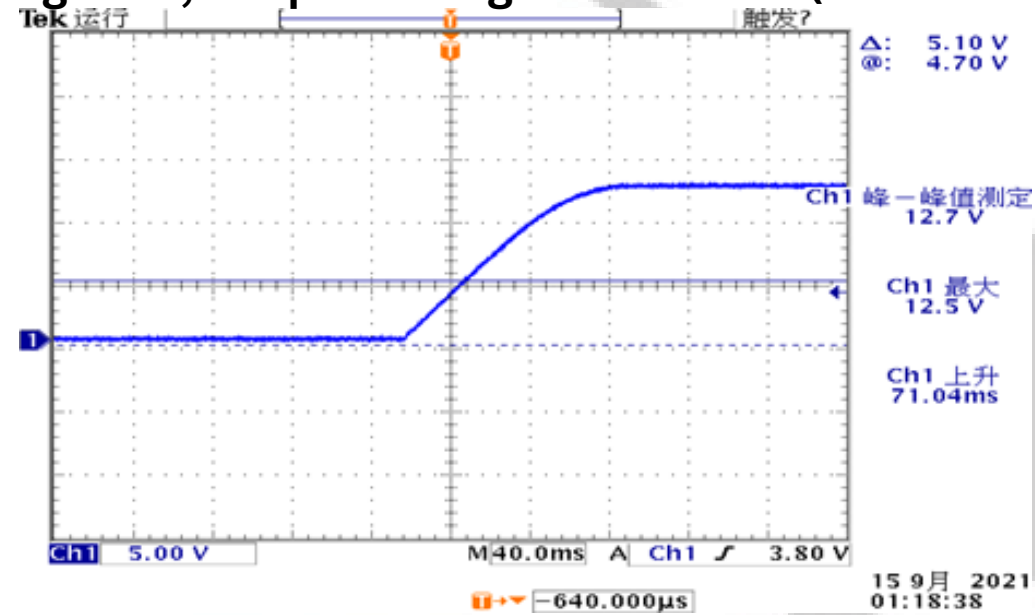
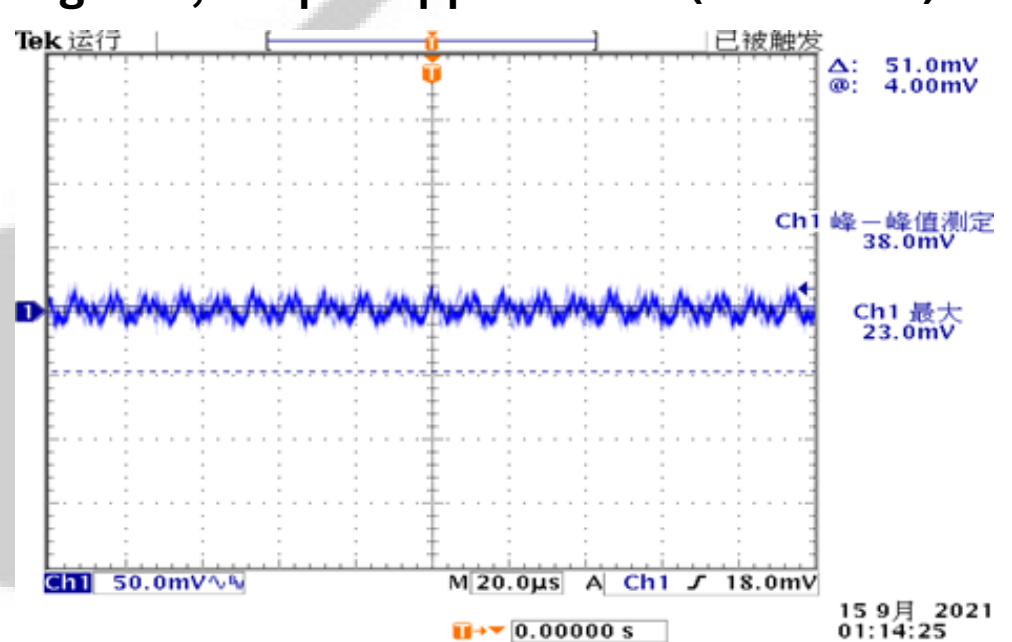

Figure 7, Output ripple & noise (Iout = 15A)



Feature Description

Remote On/Off (EN) (Optional)

Logic Enable	Low level (0-18Vdc)	High level (18-36Vdc)	Left open
positive logic	Off	On	Off

Input Undervoltage Protection

The converter will shut down after the input voltage drops below the under-voltage protection threshold for shutdown. The converter will start to work again after the input voltage reaches the input under voltage protection threshold for startup. For the Hysteresis, see the Protection characteristics.

Various circuits for driving the EN

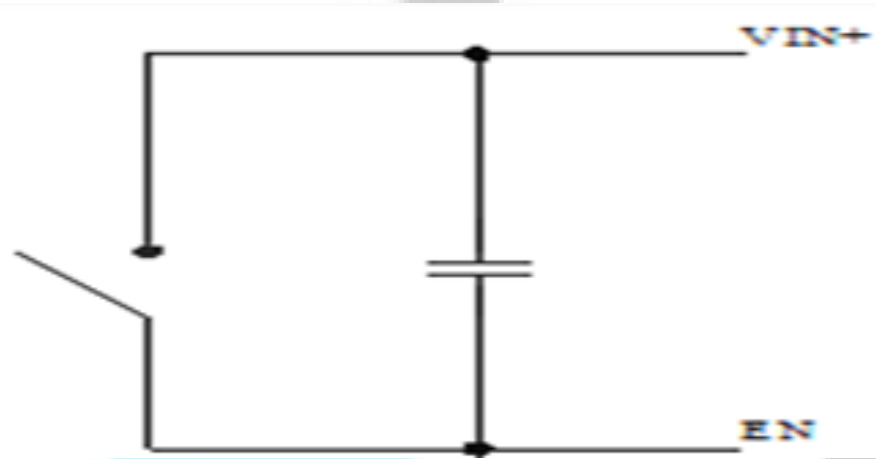

Simple control

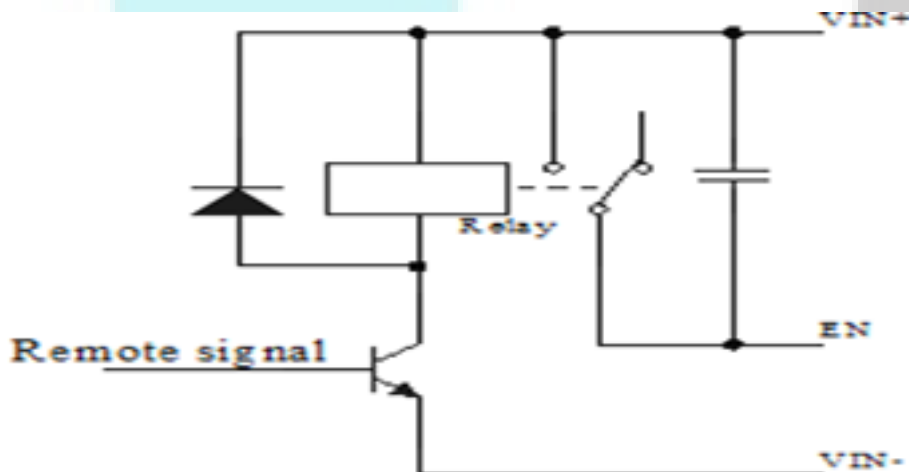

Transistor control

Output Overcurrent Protection

The converter equipped with current limiting circuitry can provide protection from an output overload or short circuit condition. If the output current exceeds the output overcurrent protection set point, the converter enters hiccup mode. When the fault condition is removed, the converter will automatically restart.

Wiring Instructions

The input and output of this product is terminals. The user should ensure that the input and output wires and terminals are connected reliably, and pay attention to the wire diameter to meet the requirements of the power supply current. If the cable to be used is long, it needs considering the voltage drop of the wire, if the voltage drop is too large, the voltage output at the load end may not meet the load demand. In this case, consider using a thicker wire diameter or reducing the length of the wire. Generally, if long wiring is required, long line should be used on the side where the current is relatively small. For example, this product is a step-down product, so long lines should be used on the input side.

Overtemperature Protection

A temperature sensor on the converter senses the average temperature of the module. It protects the converter from being damaged at high temperatures. When the temperature exceeds the over temperature protection threshold, the output will shut down. It will allow the converter to turn on again when the temperature of the sensed location falls by the value of Over temperature Protection Hysteresis.

Thermal Consideration

Sufficient airflow should be provided to help ensure reliable operating of the RW-982-24-12V-180W

Therefore, thermal components are mounted on the top surface of the RW-982-24-12V-180W to dissipate heat to the surrounding environment by conduction, convection, and radiation. Proper airflow can be verified by measuring the temperature at the middle of the base plate.



unit: mm

