

Input Voltage	Output voltage	Output current	Output Power	Efficiency	Dimension
18-36V	12V	60A	720W	97.2%	3048*266*63mm



The RW-989-24-12V-720W is a Non-isolated DC-DC converter that uses a synchronous rectification technology, and features high efficiency and power density. It has the dimensions of 3048mm x 266mm x 63mm (5.51 in. x 4.72 in. x 1.67 in) and provides the rated output voltage of 12V and the maximum output current of 60A.

Features

- Design meeting RoHS / CE
- High efficiency: 97.2% (@24Vin, 25°C)
- Non-isolated between input and output
- Remote ON/OFF control (optional)
- Support -40 °C environment
- 100% full load burn-in test
- 3 month warranty
- Waterproof level IP68
- Short circuit, Over load, Over temperature protections
- 100% full stable current output

Applications

- Industrial
- Alternative Energy
- Golf Cart
- Forklift
- Electromotor
- Telecommunications
- Boat & Yacht
- Medical
- LED Marketplaces and so on

Model naming method

RW-989-24-12V-720W

RW-989: SKU NAME
24: Input voltage range
12V: Output voltage
720W: POWER

Datasheet

Parameter	Min	Typ	Max	Units	Remarks
Absolute maximum ratings					
Operating ambient temperature	-40	-	+50	°C	
Shell ambient temperature	-40	-	80	°C	
Storage temperature	-55	-	100	°C	
Operating humidity	5	-	95	%	Non-condensing
Atmospheric pressure	62	-	106	kpa	
Altitude	-	-	4000	m	
Cooling way	-	-	-		Natural cooling
Input characteristics					
Input voltage	18	24	36	V	
Max. input voltage	-	-	40	V	Continuous
Undervoltage shutdown	17.4	17.6	17.8	V	Automatic recovery
Undervoltage recovery	17.8	18.0	18.2	V	Automatic recovery
Max. input current	-	-	44.2	A	Vin =17.8V; Iout =60A
No load current	-	56	100	mA	Vin =24V
Positive electrode cable	10	-	-	AWG	If the wire length is greater than 50cm, it is recommended to use a thicker wire diameter.
Negative electrode cable	10	-	-	AWG	

Enable PIN cable	-	-	-	AWG	If the unit with this function
Fuse	-	60	-	A	Input positive has built-in fuse
Output characteristics					
Efficiency	-	97.2	-	%	Vin =24V; Iout=100A
Output voltage	11.9	12.0	12.3	V	Vin =24V; Iout=100A
Regulator accuracy	-	±2	-	%	
Voltage regulation	-	±2	-	%	
Load Regulation	-	±2	-	%	
Overvoltage protection	-	-	-	V	
Output current	0	-	60	A	Vin =18-36V
Overcurrent protection	-	70	75	A	Vin=24V
External capacitance	-	NA	-	μF	Don't need
Output ripple and noise	-	56	200	mVp-p	Vin =18-36V; Iout=60A, Oscilloscope bandwidth: 20 MHz
Output voltage risetime	-	70.8	100	mS	
Boot delay time	-	85.2	200	mS	
Out voltage overshoot	-	1	2	%	Vin =24V, 50%-75%Load step
Over temperatur protection	-	-	90	°C	Shell

Short circuit protection	-	YES	-		Long-term (4 hours)short circuit is not damaged, Hiccupmode
Positive electrode cable	8	-	-	AWG	If the wire length is greater than 50cm, it is recommended to use a thicker wire diameter
Negative electrode cable	8	-	-	AWG	
Safety and EMC features					
Anti-electric Strength	Input to Output	-	V	Leakage current \leq 3.5mA, 1min, no breakdown, no arcing	
	Input to Shell	≥ 500	V		
	Output to Shell	≥ 500	V		
Insulation resistance	Input to Output	≥ 50	M Ω	Test voltage = 500V	
	Input to Shell				
	Output to Shell				
Other characteristics					
Weight	≤ 2.2	kg			
Package	white box				
MTBF	$\geq 200,000$	H	Vin= 24V; Iout= 60A		
Switching frequency	100 \pm 10	KHz			

Characteristic Curves

Conditions: $T_A = 25^\circ\text{C}$ (77°F), $V_{in} = 24\text{V}$, $V_{out} = 12\text{V}$, unless otherwise specified

Figure 1, Efficiency

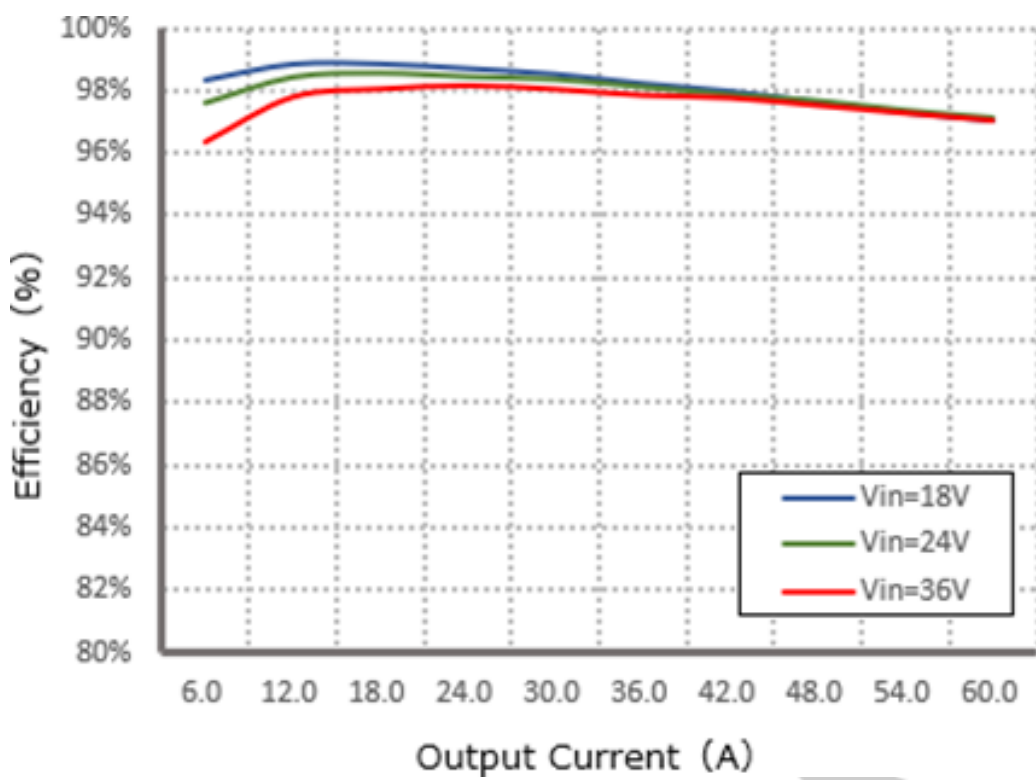

Figure 2, Power dissipation

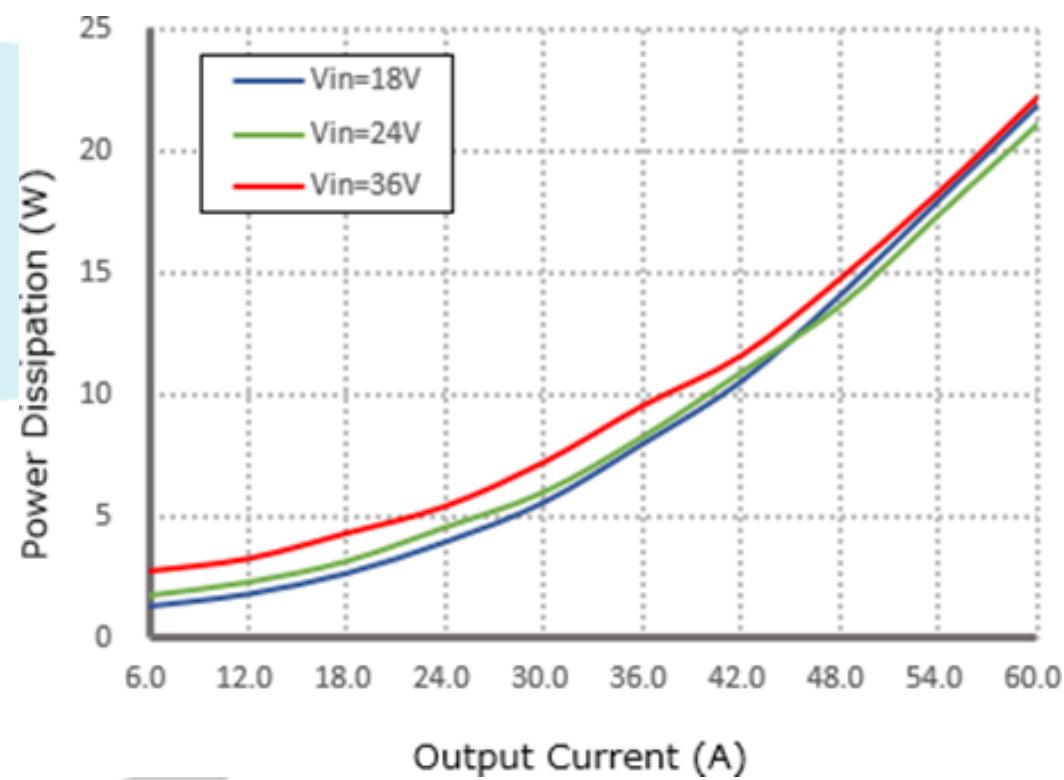
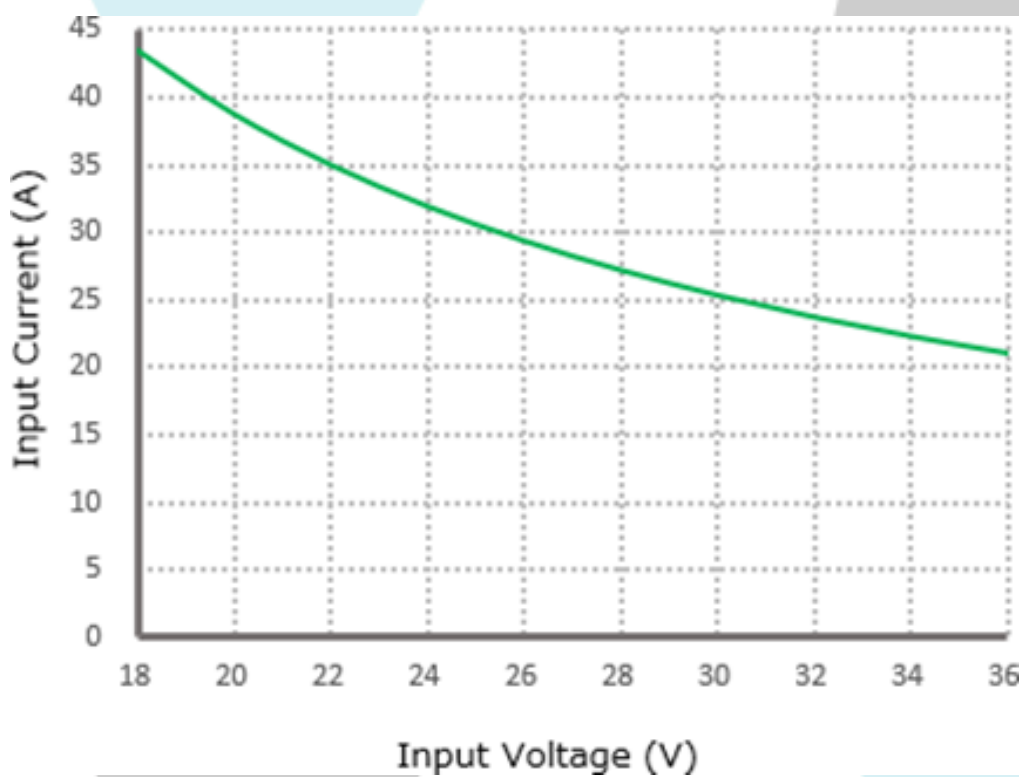

Figure 3, Input V-I, $I_{out}=60\text{A}$



Typical Waveforms

Conditions: TA = 25°C (77°F), Vin = 24V, unless otherwise specified.

Figure 4, 25% - 50%load dynamic

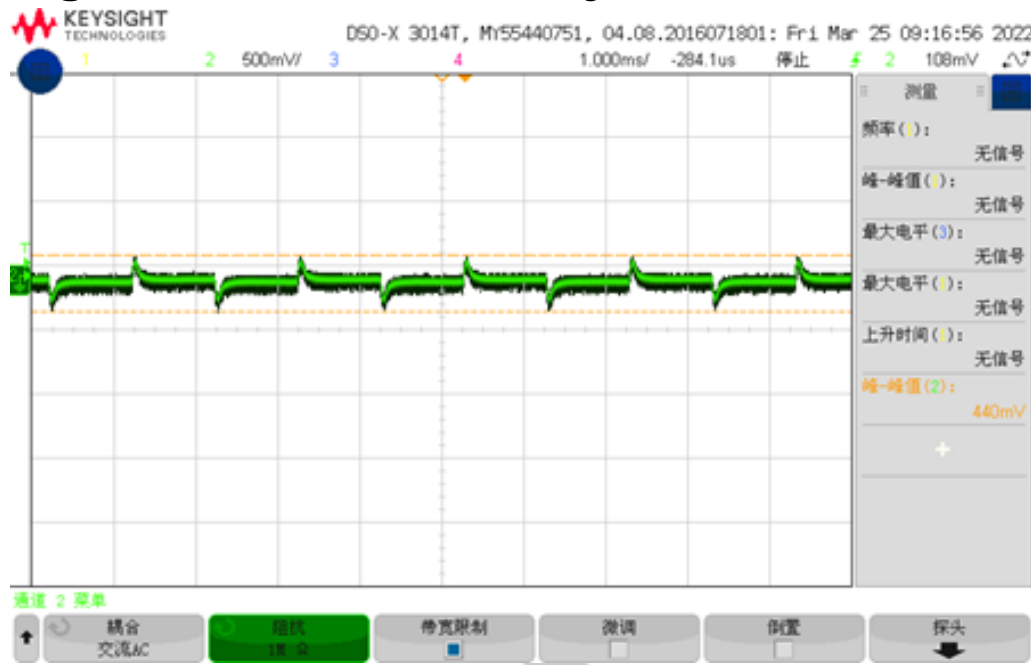

Figure 5, 50% - 75%load dynamic



Figure 6, Output voltage established (Iout = 60A)

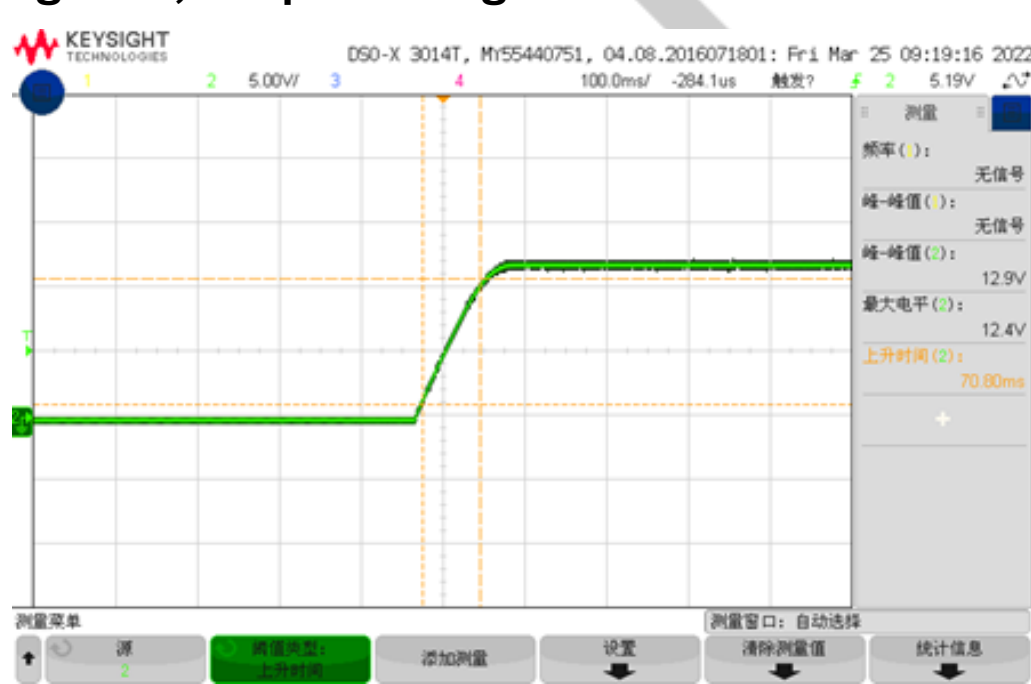

Figure 7, Output ripple & noise (Iout = 60A)

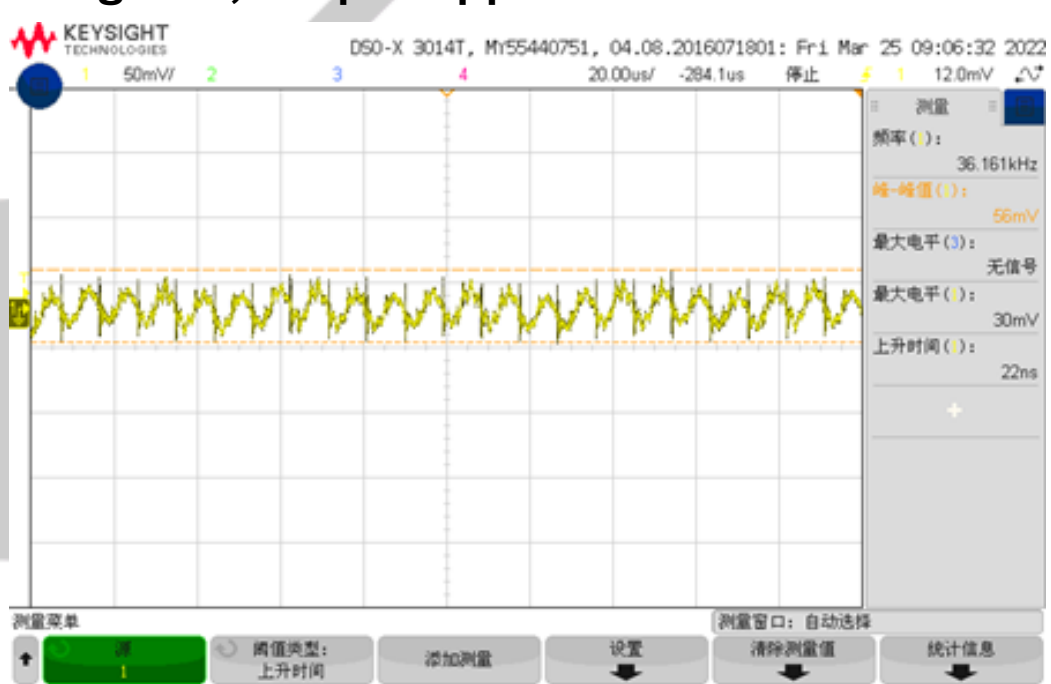

Figure 8, Boot delay time (Iout = 60A)

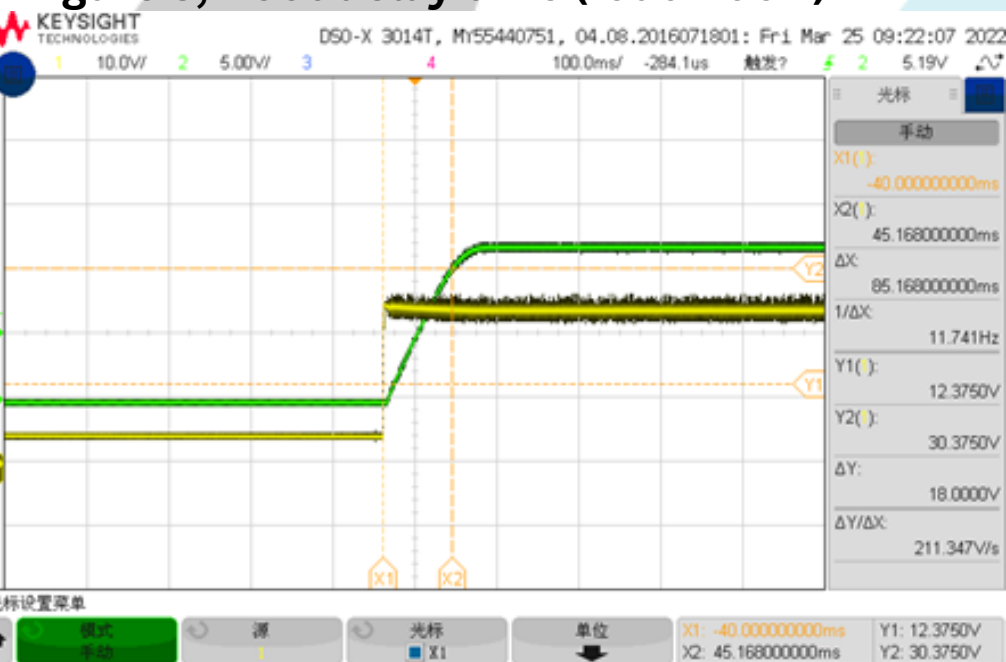
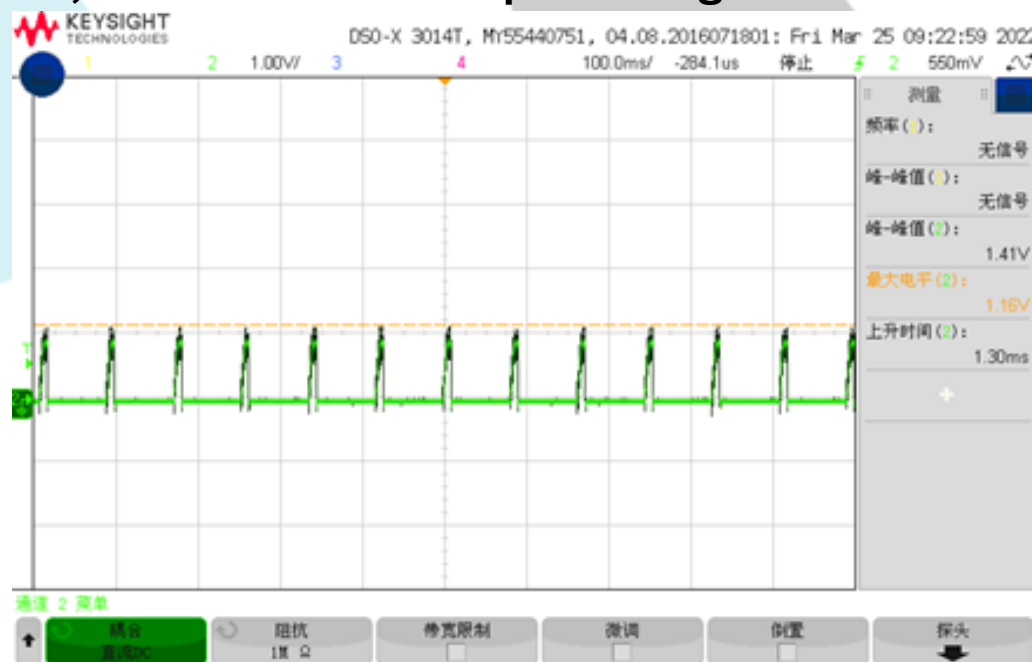

Figure 9, Short-circuit & Output voltage (Iout = 60A)



Feature Description

Remote On/Off (EN) (Optional)

Logic Enable	Low level (0-18Vdc)	High level (18-36Vdc)	Left open
positive logic	Off	On	Off

Input Undervoltage Protection

The converter will shut down after the input voltage drops below the under-voltage protection threshold for shutdown. The converter will start to work again after the input voltage reaches the input under voltage protection threshold for startup. For the Hysteresis, see the Protection characteristics.

Various circuits for driving the EN

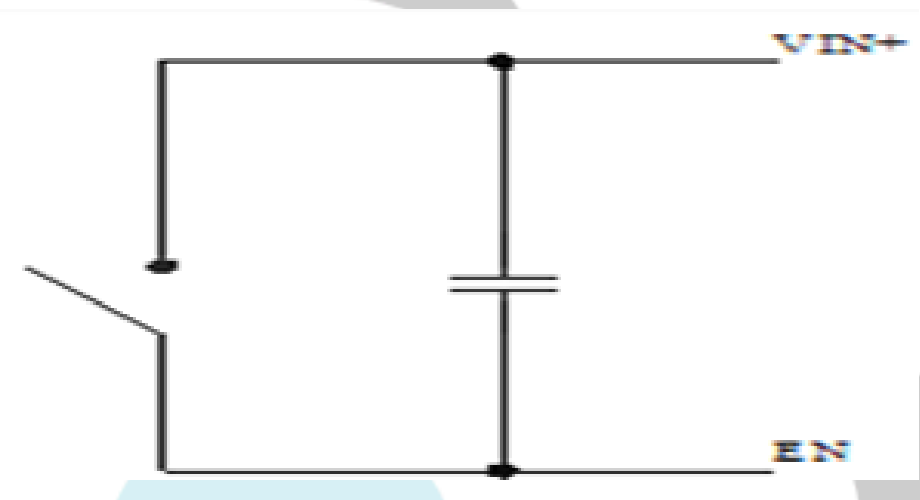

Simple control

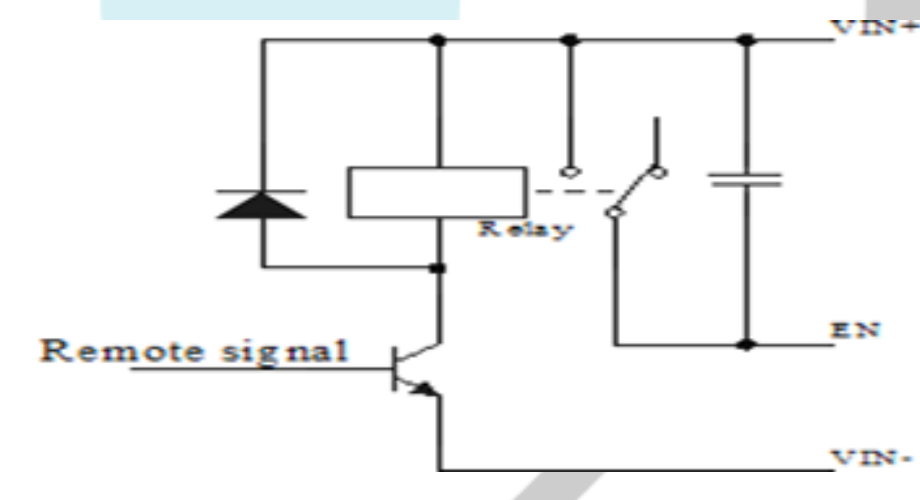

Transistor control

Output Overcurrent Protection

The converter equipped with current limiting circuitry can provide protection from an output overload or short circuit condition. If the output current exceeds the output overcurrent protection set point, the converter enters hiccup mode. When the fault condition is removed, the converter will automatically restart.

Wiring Instructions

The input and output of this product is terminals. The user should ensure that the input and output wires and terminals are connected reliably, and pay attention to the wire diameter to meet the requirements of the power supply current. If the cable to be used is long, it needs considering the voltage drop of the wire, if the voltage drop is too large, the voltage output at the load end may not meet the load demand. In this case, consider using a thicker wire diameter or reducing the length of the wire. Generally, if long wiring is required, long line should be used on the side where the current is relatively small. For example, this product is a step-down product, so long lines should be used on the input side.

Overtemperature Protection

A temperature sensor on the converter senses the average temperature of the module. It protects the converter from being damaged at high temperatures. When the temperature exceeds the over temperature protection threshold, the output will shut down. It will allow the converter to turn on again when the temperature of the sensed location falls by the value of Over temperature Protection Hysteresis.

Thermal Consideration

Sufficient airflow should be provided to help ensure reliable operating of the RW-989-24-12V-720W

Therefore, thermal components are mounted on the top surface of the RW-989-24-12V-720W to dissipate heat to the surrounding environment by conduction, convection, and radiation. Proper airflow can be verified by measuring the temperature at the middle of the base plate.

