

Input voltage	Output voltage	Output current	Output power	Efficiency	Size
18-36V DC	12V DC	1.5 Amps	18 Watts	95.3%	63*32*18mm

The RW-981-24-12V-18W is a Non-isolated DC-DC converter that uses a synchronous rectification technology, and features high efficiency and power density. It has the dimensions of 63*32*18mm (2.48 in. x 1.26 in. x 0.71 in) and provides the rated output voltage of 12 V and the maximum output current of 1.5A.



Features

- Design meeting RoHS / CE
- High efficiency: 90.8% (@ 24Vin, 25°C)
- Import capacitors, high reliability
- Output transient absorption protection
- Support -40 °C environment
- 100% full load burn-in test
- 3 month warranty
- Remote ON/OFF control (optional)
- Waterproof level IP68

Applications

- Industrial
- Alternative Energy
- Golf Cart
- Forklift
- Electromotor
- Telecommunications
- Boat & Yacht
- Medical
- LED Marketplaces and so on.

Model naming method
RW-981-24-12V-18W

RW-981: SKU NAME
24V Input voltage
12V : Output voltage
18W: Output Power

Electrical Specifications

Conditions: TA = 25 °C (77°F), Airflow = 1 m/s (200LFM), Vin =24V, Vout =12V, unless otherwise specified.

Parameter	Min.	Typ	Max.	Units	Remarks
Absolute maximum ratings					
Operating ambient temperature	-40	-	+50	°C	
Shell ambient temperature	-40	-	80	°C	
Storage temperature	-55	-	100	°C	
Operating humidity	5	-	95	%	Non-condensing
Atmospheric pressure	62	-	106	Kpa	
Altitude	-	-	4000	m	
Cooling way	-	-	-		Natural cooling

Input characteristics

Input voltage	18	24	36	V	-
Max. input voltage	-	-	36	V	Continuous
Undervoltage shutdown	15.0	16.5	16.7	V	Automatic recovery
Undervoltage recovery	17.3	17.4	17.6	V	Automatic recovery
Max. input current	-	-	1.2	A	Vin =18V; Iout =1.5A
No load current	-	0.8	1	mA	Vin = 24V

Positive electrode cable	22	-	-	AWG	If the wire length is greater than 50cm, it is recommended to use a thicker wire diameter.
Negative electrode cable	22	-	-	AWG	
Enable PIN cable	-	NA	-	AWG	If the unit with this function
Fuse	-	10	-	A	Input positive has built-in fuse

Output characteristics

Efficiency	-	95.3	-	%	Vin =24V; Iout =1.5A
Output voltage	11.9	12.0	12.3	V	Vin =24V; Iout =1.5A
Regulator accuracy	-	±2	-	%	
Voltage regulation	-	±2	-	%	
Load Regulation	-	±3	-	%	
Overvoltage protection	-	NA	-	V	
Output current	0	-	1.5	A	
Overcurrent protection	3	4	5	A	Vin=18-36V
External capacitance	0	NA	-	μF	Don't need
Output ripple and noise	-	20	120	mVp-p	Vin =18-36V; Iout=1.5A Oscilloscope bandwidth: 20 MHz
Output voltage rise time	-	2.6	30	mS	
Boot delay time	-	120	200	mS	
Out voltage overshoot	-	1	2	%	Vin =24V
Over temperature protection	-	NA		°C	
Short circuit protection	-	Yes	-		Long-term (4 hours) short circuit is not damaged, Hiccup mode
Positive electrode cable	22	-	-	AWG	If the wire length is greater than 50cm, it is recommended to use a thicker wire diameter.
Negative electrode cable	22	-	-	AWG	

Feature Description

Remote On/Off (EN) (Optional)

Logic Enable	Low level (0 - 18Vdc)	High level (18-36Vdc)	Left open
Positive logic	Off	On	Off

Input Undervoltage Protection

The converter will shut down after the input voltage drops below the under-voltage protection threshold for shutdown. The converter will start to work again after the input voltage reaches the input under voltage protection threshold for startup. For the Hysteresis, see

Various circuits for driving the EN

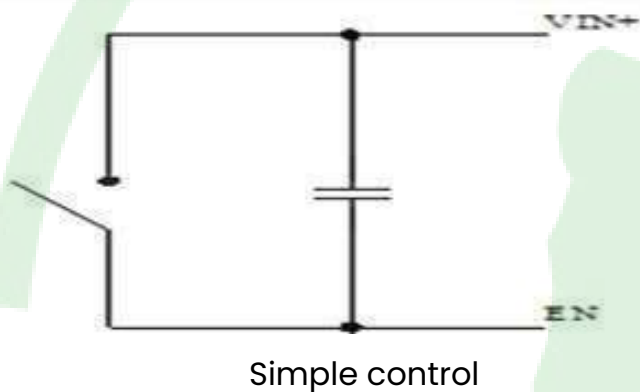

Simple control

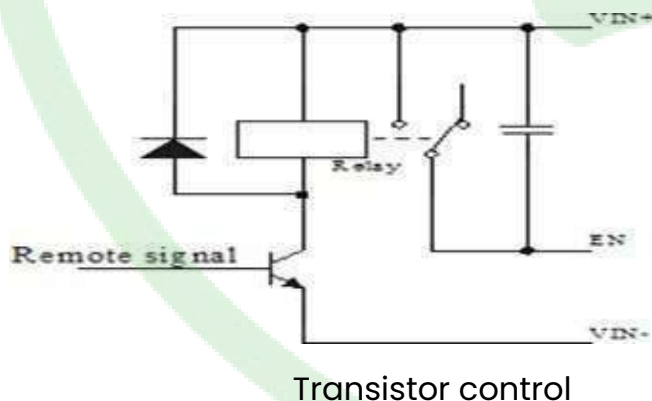

Transistor control

Output Overcurrent Protection

The converter equipped with current limiting circuitry can provide protection from an output overload or short circuit condition. If the output current exceeds the output overcurrent protection set point, the converter enters hiccup mode. When the fault condition is removed, the converter will automatically restart.

Wiring Instructions

The input and output of this product is terminals. The user should ensure that the input and output wires and terminals are connected reliably, and pay attention to the wire diameter to meet the requirements of the power supply current. If the cable to be used is long, it needs considering the voltage drop of the wire, if the voltage drop is too large, the voltage output at the load end may not meet the load demand. In this case, consider using a thicker wire diameter or reducing the length of the wire. Generally, if long wiring is required, long line should be used on the side where the current is relatively small. For example, this product is a step-down product, so long lines should be used on the input side.

DIAGRAM WIRING

INPUT+ TO BATTERY+

INPUT- TO BATTERY-

OUTPUT+ TO LOAD+

OUTPUT- TO LOAD-

Notes: Never reverse the input polarity, or it burns the converter.

REVISION HISTORY

rev.	description	date
1.0	initial release	April 2022
2.0	revision	Nov 2024

Safety and EMC features

Anti-electric Strength	Input to Output		V	Leakage current $\leq 3.5\text{mA}$, 1min, no breakdown, no arcing
	Input to Shell	≥ 500	V	
	Output to Shell	≥ 500	V	
Insulation resistance	Input to Output	≥ 10	$\text{M}\Omega$	Test voltage = 500V
	Input to Shell			
	Output to Shell			

Other characteristics

Weight	≤ 70	g	
Package	White box		
MTBF	$\geq 200,000$	H	$V_{in} = 24\text{V}; I_{out} = 1.5\text{A}$
Switching frequency	135 ± 10	KHz	

Characteristic Curves

Conditions: $T_A = 25^\circ\text{C}$ (77°F), $V_{in} = 24\text{V}$, $V_{out} = 12\text{V}$, unless otherwise specified

Figure 1, Efficiency

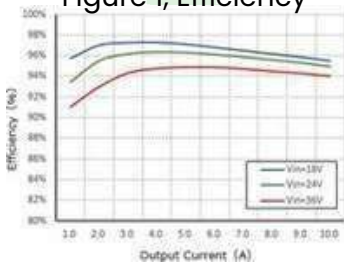

Figure 3, Input V-I, $I_{out}=1.5\text{A}$

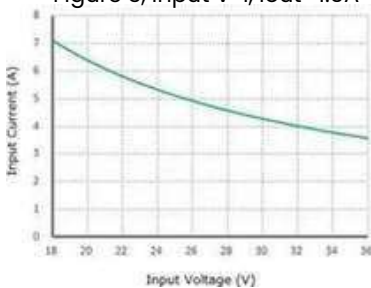
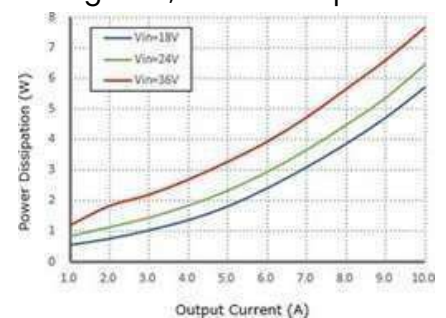

Figure 2, Power dissipation



Typical Waveforms

Conditions: TA = 25°C (77°F), Vin = 24V, unless otherwise specified.

Figure 4, 25% - 50% load dynamic

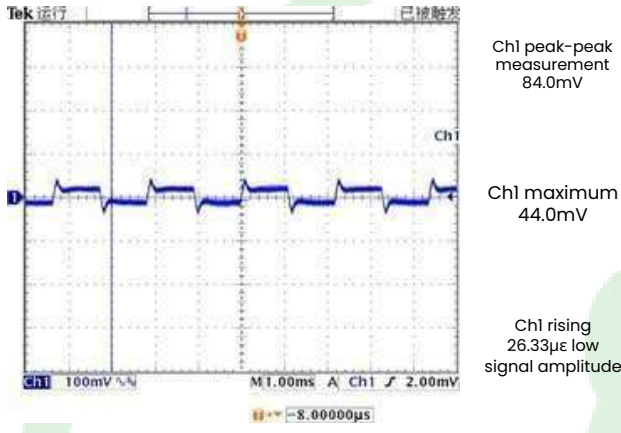

Figure 5, 50% - 75% load dynamic

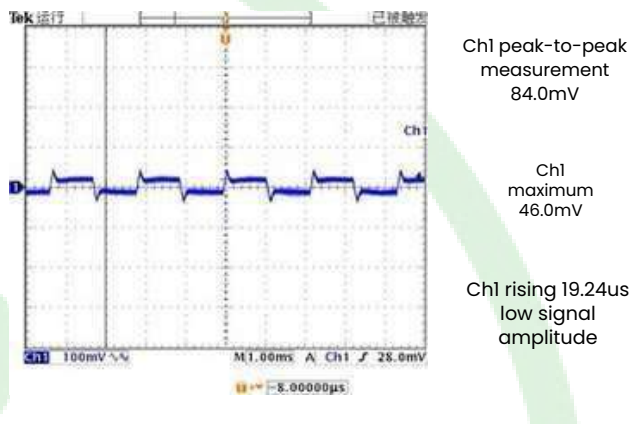

Figure 6, Output voltage established (Iout = 1.5A)

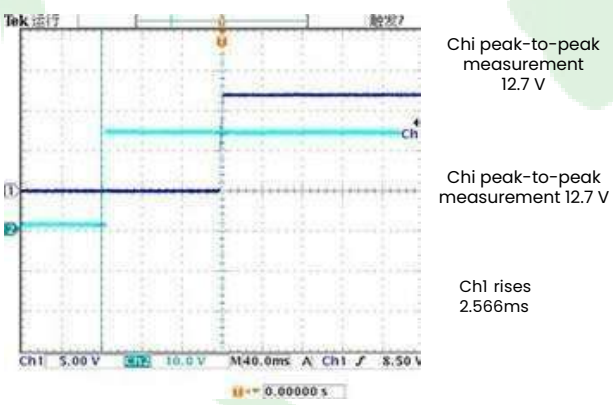
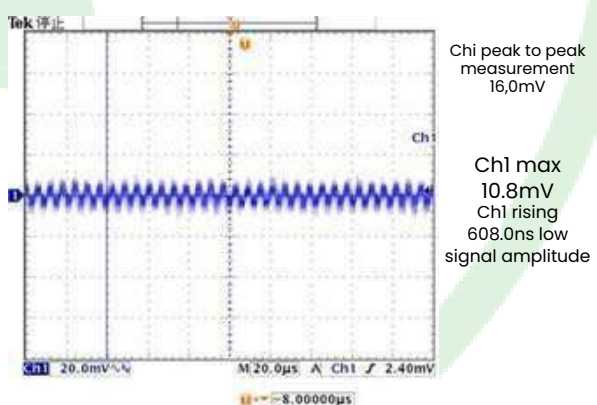

Figure 7, Output ripple & noise (Iout = 1.5A)



SAFETY AND COMPLIANCE

Parameter	Test conditions or description			
safety approvals	EN 61000-6-3:2007/A1:2011/AC:2012 EN 55014-1:2006/A2:2011 EN 60950-1:2006/AC:2011			
enclosures	IP68			

ENVIRONMENTAL

Parameter	Test conditions or description	Min	Typ	Max	Units
case operating temperature		40	25	85	°C
ambient temperature		-20		85	°C
storage temperature		40		95	°C
humidity				95	%

Thermal Consideration

Sufficient airflow should be provided to help ensure reliable operating of the RW-981-24-12V-18W. Therefore, thermal components are mounted on the top surface of the RW-981-24-12V-18W to dissipate heat to the surrounding environment by conduction, convection, and radiation. Proper airflow can be verified by measuring the temperature at the middle of the base plate.

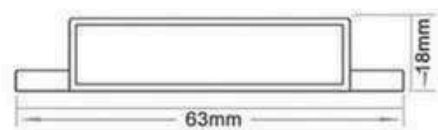
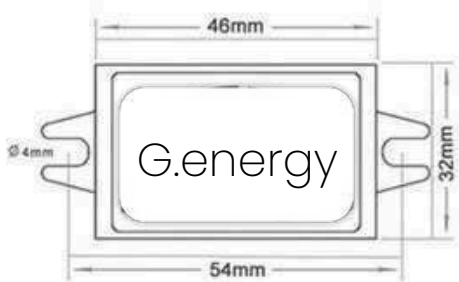
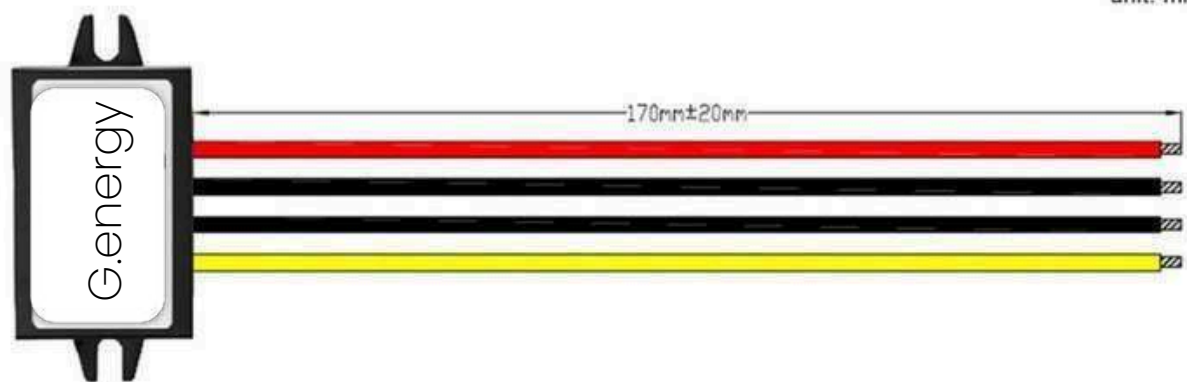

NEWTECH ENTERPRISES Ltd reserves the ©copyright and right of final interpretation.