

Input voltage	Output voltage	Output current	Output power	Efficiency	Size
30-60V DC	24V DC	30 Amps	720 Watts	98.4%	100*80*39mm

The RW-1135-48-24V-720W is a Non-isolated DC-DC converter that uses a synchronous rectification technology, and features high efficiency and power density. It has the dimensions of 100\*80\*39mm (3.94 in. x 3.15 in. x 1.54 in) and provides the rated output voltage of 24V and the maximum output current of 30A.

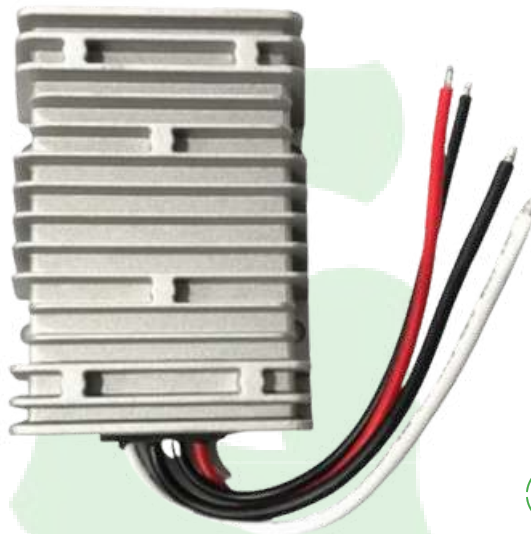

### Features

- Design meeting RoHS / CE
- High efficiency: 98.4% (@ 48Vin, 25°C)
- Non-isolated between input and output
- Support -40 °C environment
- 100% full load burn-in test
- Short circuit, Over load, Low-voltage protections
- Waterproof level IP68
- Small size, high reliability
- 3 Months warranty

### Applications

- Industrial
- Alternative Energy
- Golf Cart
- Cars & Forklift
- Electromotor
- Telecommunications
- Boat & Yacht
- Medical
- LED Marketplaces and so on.

Model naming method  
RW-1135-48-24V-720W

**RW-1135 SKU NAME**  
48V-Input Voltage  
24V-Output Voltage  
720W-Output Power

## Electrical Specifications

Conditions: TA = 25 °C (77°F), Airflow = 1 m/s (200LFM), Vin =48V, Vout =24V, unless otherwise specified

Parameter	Min.	Typ	Max.	Units	Remarks
Absolute maximum ratings					
Operating ambient temperature	-40	-	+50	°C	
Shell ambient temperature	-40	-	80	°C	
Storage temperature	-55	-	100	°C	
Operating humidity	5	-	95	%	Non-condensing
Atmospheric pressure	62	-	106	Kpa	
Altitude	-	-	4000	m	
Cooling way	-	-	-		Natural cooling

## Input characteristics

Input voltage	30	36/48	60	V	-
Max. input voltage	-	-	60	V	Continuous
Undervoltage shutdown	26.8	27.0	27.2	V	Automatic recovery
Undervoltage recovery	27.3	27.5	27.7	V	Automatic recovery
Max. input current	-	-	27	A	Vin =30V; Iout =30A
No load current	-	41	100	mA	Vin =48V

Positive electrode cable	12	-	-	AWG	If the wire length is greater than 50cm, it is recommended to use a thicker wire diameter.
Negative electrode cable	12	-	-	AWG	
Enable PIN cable	-	-	-	AWG	If the product has this feature
Fuse	-	60	-	A	Input positive has built-in fuse

## Output characteristics

Efficiency	-	98.4%	-	%	Vin =48V; Iout =30A
Output voltage	23.9	24.0	24.3	V	Vin =48V; Iout =30A
Regulator accuracy	-	±2	-	%	
Voltage regulation	-	±1	-	%	
Load Regulation	-	±2	-	%	
Overshoot protection	-	-	-	V	
Output current	0	-	30	A	Vin =30-60V
Overcurrent protection	33	40	47	A	Vin=48V
External capacitance	-	NA	-	μF	DON'T NEED
Output ripple and noise	-	60	200	mVp-p	Vin =30-60V; Iout=30A, Oscilloscope bandwidth: 20 MHz
Output voltage rise time	-	73	100	mS	
Boot delay time	-	87	200	mS	
Out voltage overshoot	-	1	2	%	Vin =48V, 50%-75% Load step
Over temperature protection	-		90	°C	Shell
Short circuit protection	-	YES	-	-	Long-term (4 hours) short circuit is not damaged, Hiccup mode
Positive electrode cable	12	-	-	AWG	If the wire length is greater than 50cm, it is recommended to use a thicker wire diameter.
Negative electrode cable	12	-	-	AWG	

## Feature Description

### Remote On/Off (EN) (Optional)

Logic Enable	Low level (0 - 18Vdc)	High level (28-60Vdc)	Left open
Positive logic	Off	On	Off

## Input Undervoltage Protection

The converter will shut down after the input voltage drops below the under-voltage protection threshold for shutdown. The converter will start to work again after the input voltage reaches the input under voltage protection threshold for startup. For the Hysteresis, see

## Various circuits for driving the EN

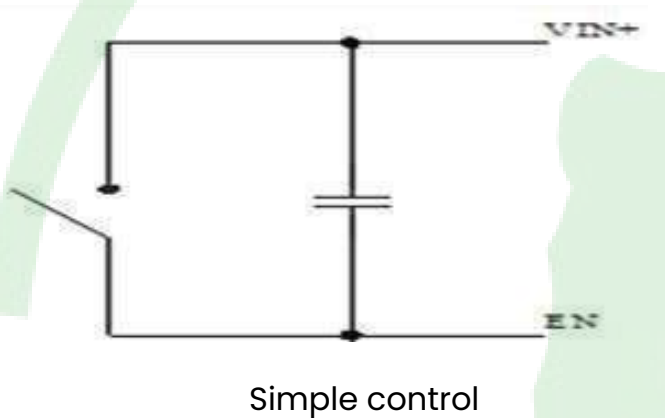

## Output Overcurrent Protection

The converter equipped with current limiting circuitry can provide protection from an output overload or short circuit condition. If the output current exceeds the output overcurrent protection set point, the converter enters hiccup mode. When the fault condition is removed, the converter will automatically restart.

## Wiring Instructions

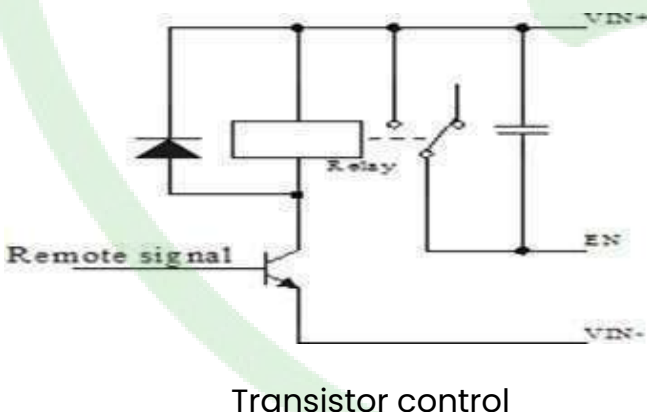

The input and output of this product is terminals. The user should ensure that the input and output wires and terminals are connected reliably, and pay attention to the wire diameter to meet the requirements of the power supply current. If the cable to be used is long, it needs Considering the voltage drop of the wire, if the voltage drop is too large, the voltage output at the load end may not meet the load demand. In this case, consider using a thicker wire diameter or reducing the length of the wire. Generally, if long wiring is required. Long line should be used on the side where the current is relatively small. For example, this product is a step-down product, so long lines should be used on the input side.

**DIAGRAM WIRING**

INPUT+ TO BATTERY+

INPUT- TO BATTERY-

OUTPUT+ TO LOAD+

OUTPUT- TO LOAD-

Notes: Never reverse the input polarity, or it burns the converter.

**REVISION HISTORY**

rev.	description	date
1.0	initial release	April 2022
2.0	revision	Nov 2024

### Safety and EMC features

Anti-electric Strength	Input to Output	-	V	Leakage current $\leq 3.5\text{mA}$ , 1min, no breakdown, no arcing
	Input to Shell	$\geq 500$	V	
	Output to Shell	$\geq 500$	V	
Insulation resistance	Input to Output	$\geq 10$	M $\Omega$	Test voltage = 500V
	Input to Shell			
	Output to Shell			

### Other characteristics

Weight	$\leq 550$	g	
Package	White box		
MTBF	$\geq 200,000$	H	Vin = 48V; Iout = 30A
Switching frequency	100 $\pm$ 10	KHz	

### Characteristic Curves

Conditions: TA = 25°C (77°F), Vin = 48V, Vout = 24V, unless otherwise specified.

Figure 1, Efficiency

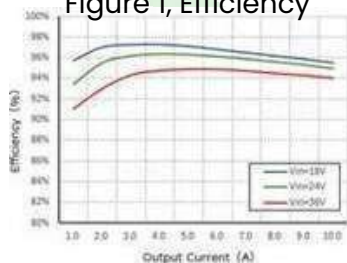

Figure 3, Input V-I, Iout=30A

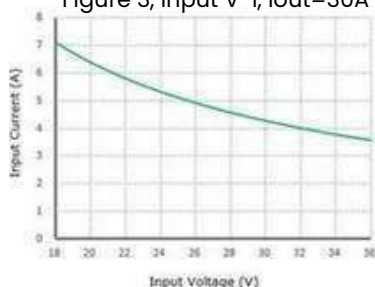
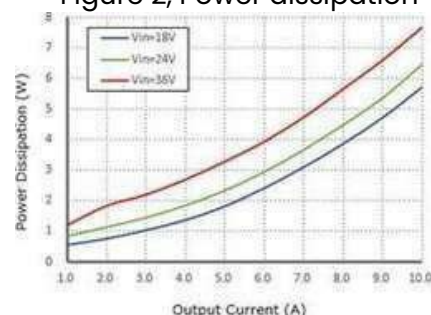

Figure 2, Power dissipation





## Typical Waveforms

Conditions:  $T_A = 25^\circ\text{C}$  (77°F),  $V_{in} = 48\text{V}$ , unless otherwise specified..

Figure 4, 25% - 50% load dynamic



Figure 5, 50% - 75% load dynamic



Figure 6, Output voltage established ( $I_{out} = 30\text{A}$ )

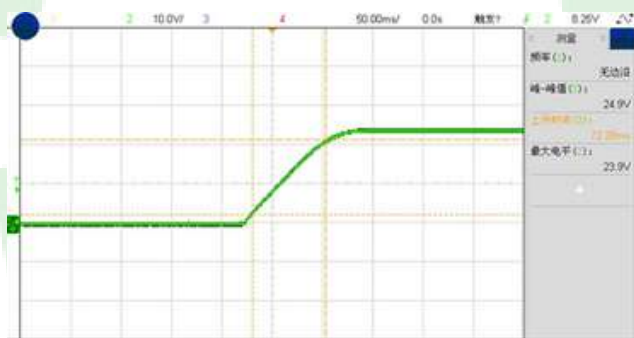

Figure 7, Output ripple & noise ( $I_{out} = 30\text{A}$ )

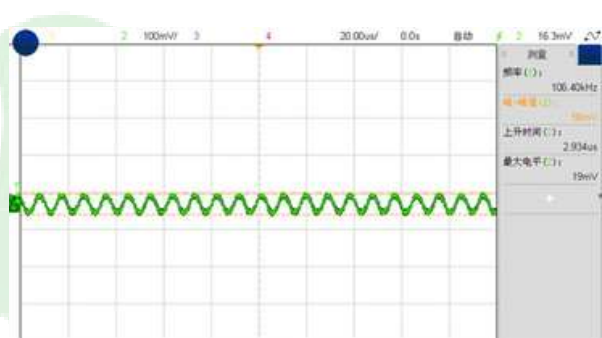

Figure 8, Boot delay time ( $I_{out} = 30\text{A}$ )

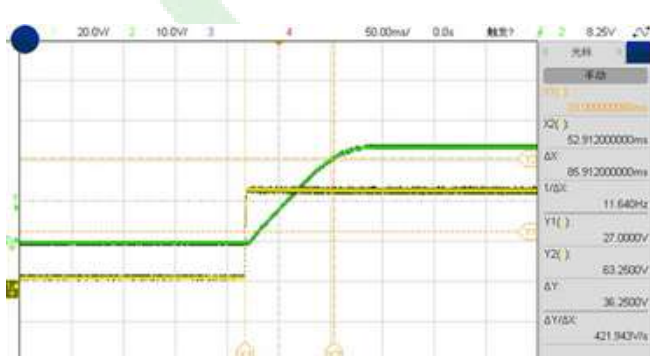
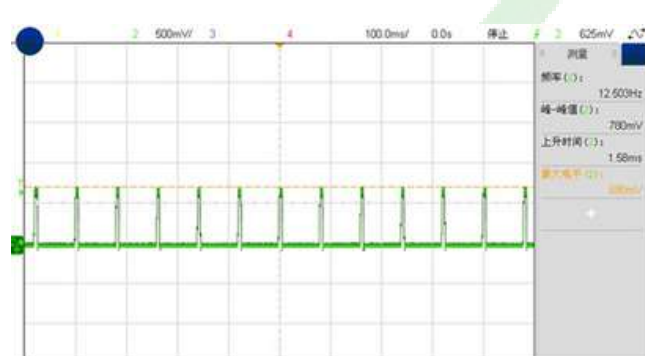

Figure 9, Short-circuit & Output voltage ( $I_{out} = 30\text{A}$ )





### Thermal Consideration

Sufficient airflow should be provided to help ensure reliable operating of the RW-1135-48-24V-720W. Therefore, thermal components are mounted on the top surface of the RW-1135-48-24V-720W to dissipate heat to the surrounding environment by conduction, convection, and radiation. Proper airflow can be verified by measuring the temperature at the middle of the base plate.

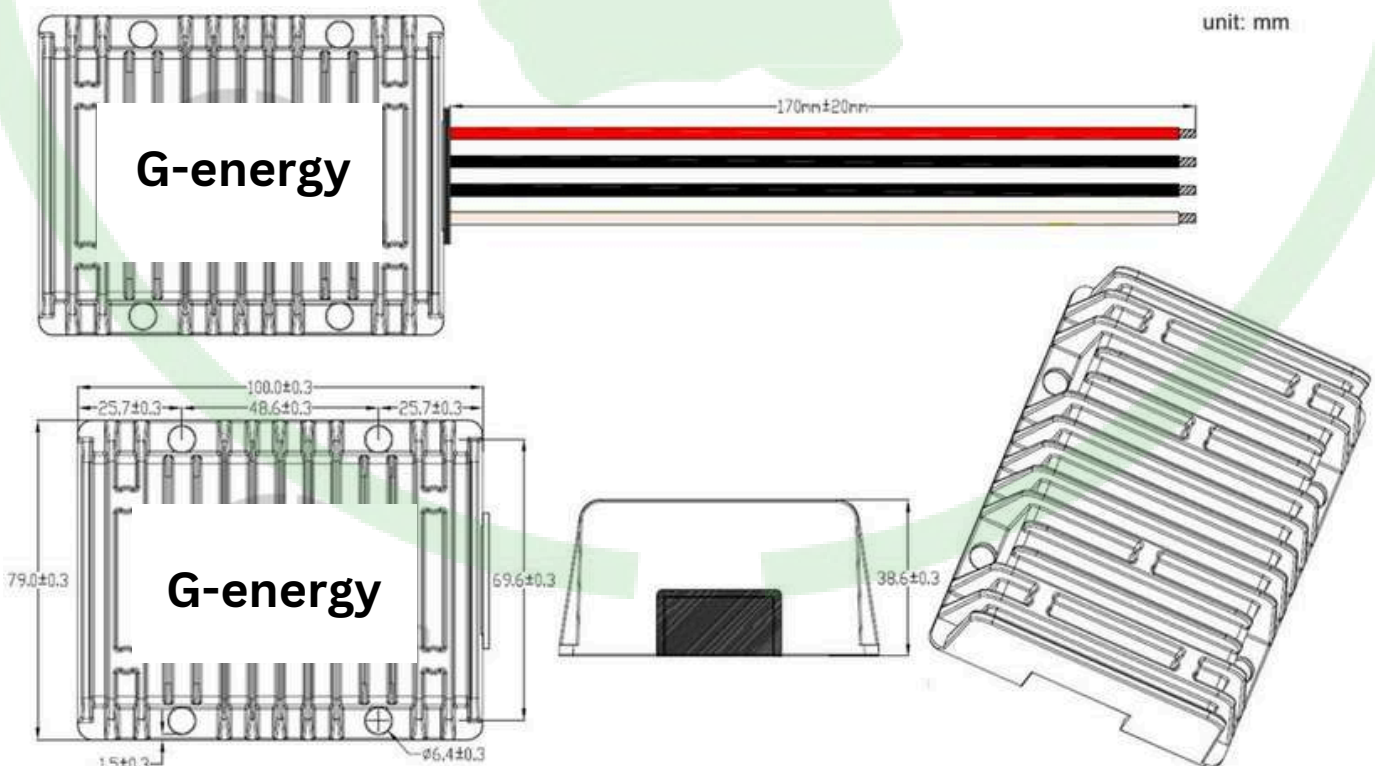

NEWTECH ENTERPRISES Ltd reserves the ©copyright and right of final interpretation.